

# Zeramex XT

## User guide



# Zeramex XT

XT

Dear Zeramex XT user,

The Zeramex XT implant system is a pioneer in the field of two-piece, reversible screw-retained and 100% metal-free ceramic implants.

The root-shaped design of the Zeramex XT implants achieves high primary stability and offers optimal prosthetic flexibility due to its unique internal connection.

The uncomplicated portfolio offers all the options to choose from. Find out all about the completely digital workflow for the Zeramex implant systems today. Improve patient satisfaction and facilitate your work in the process.

Our experts will be glad to help you if you have any questions.

## **Zeramex Hotline**

Phone: 00800 93 55 66 37  
(toll-free from a landline in Germany,  
Austria, and Switzerland)  
E-mail: [info@zeramex.com](mailto:info@zeramex.com)

## **Zeramex Digital Solutions**

Phone: 00800 04 00 13 33  
(toll-free from a landline in Germany,  
Austria, and Switzerland)  
E-mail: [digitalsolutions@zeramex.com](mailto:digitalsolutions@zeramex.com)





# Zeramex XT

## Contents

### Information

- 4 System overview
- 8 Case planning in 5 steps
- 10 Surgical tools
- 12 Sterilisation and instrument care
- 14 Technical information

### Surgical phase

- 18 Planning the insertion depth
- 20 Drilling protocols
- 25 Handling

### Prosthetic restoration

- 28 Soft tissue management
- 28 Temporary restoration
- 29 Digital impression taking
- 30 Conventional impression taking
- 32 Prosthetic process
- 33 Prosthetic tools
- 34 Screwed connection
- 38 Cemented connection
- 39 Platform switching
- 40 CAD/CAM workflow
- 42 Zeramex Digital Solutions

- 44 Zeramex Docklocs® abutments
- 46 Technical data for abutments
- 47 Grinding standard abutments
- 48 Zeramex XT screws

### Range

- 51 Range

### Note

- 67 General Information
- 69 Contact

### Caution!

The Zeramex XT system is not compatible with previous Zeramex T generations. If you have any questions or concerns, please don't hesitate to contact us on 00800 93 55 66 37.

# System overview

The system is suitable for all common indications, particularly for anterior tooth restorations.

## Biocompatible tools

### Zeradrill

The biocompatible reusable drill with carbon coating (DLC)

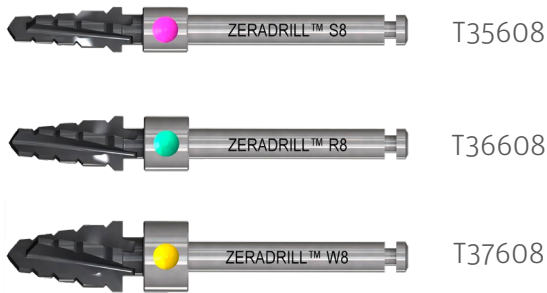

### Zeratap

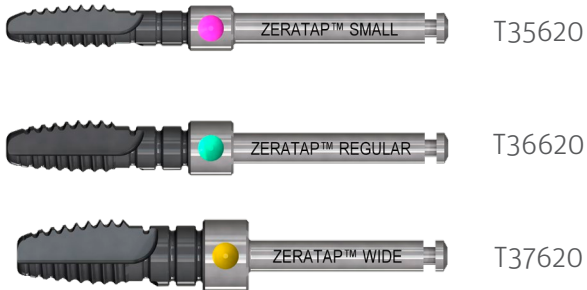

### Surgical Kit



### Prosthetic Kit

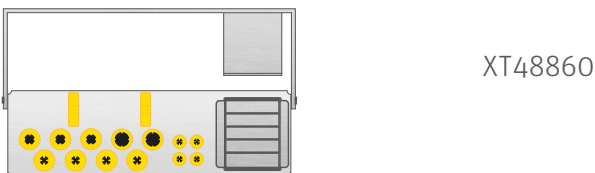

## Colour coding and sizes

### Example of implant

Regular  $\varnothing 4.2 \times 14$  mm

	SB $\varnothing 3.5$ mm	RB $\varnothing 4.2$ mm	WB $\varnothing 5.5$ mm
$\varnothing$ Platform	3.85 mm	4.2 mm	5.5 mm
$\varnothing$ Endosseous	3.5 mm	4.2 mm	5.5 mm
Collar height	1.6 mm	1.6 mm	1.6 mm
Optional	0.6 mm	0.6 mm	0.6 mm

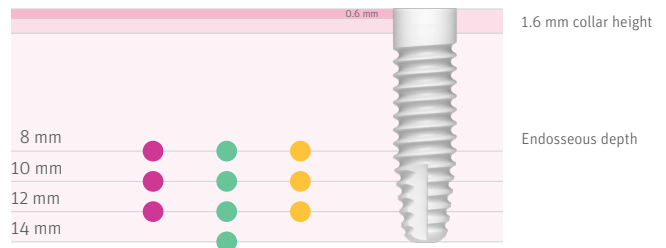

SB = Small Base  
 RB = Regular Base  
 WB = Wide Base

## Imaging and Connection Tools











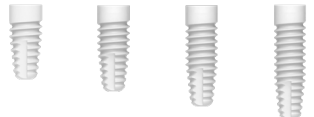
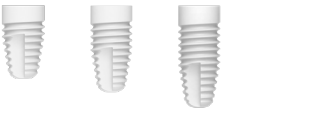



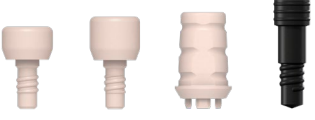
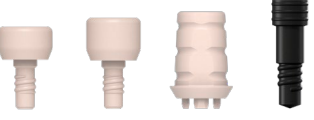
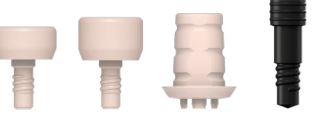



### Surgery



### Prosthetic



# System overview

<b>Implants (ø endosseous)</b> Material: ZrO <sub>2</sub> ATZ	<b>Zeremex XT ø3.5 mm SB</b>  XT15508 XT15510 XT15512	<b>Zeremex XT ø4.2 mm RB</b>  XT16508 XT16510 XT16512 XT16514	<b>Zeremex XT ø5.5 mm WB</b>  XT17508 XT17510 XT17512
<b>Prosthetic platform</b>	<b>SB ø3.85 mm</b>	<b>RB ø4.2 mm</b>	<b>WB ø5.5 mm</b>
<b>Healing caps</b> Material: PEEK	 SB35500	 RB36500	 WB37500
<b>Soft Tissue Management Gingiva former, provisional abutments</b> Material: PEEK, Vicarbo	 SB35503 SB35504 SB35530	 RB36503 RB36504 RB36530	 WB37503 WB37504 WB37530
<b>Taking an impression open/closed</b> Material: PEEK-CW30, Aluminium	 SB35510 SB35512 SB35513	 RB36510 RB36512 RB36513	 WB37510 WB37512 WB37513
<b>Digital impression taking Scanbody</b> Material: PEEK, PEEK-CW30	 SB35514	 RB36514	 WB37514
<b>Standard Abutments/ Abutments Digital Workflow including screw</b> Material: ZrO <sub>2</sub> ATZ, Vicarbo  <i>*Sample images: Differs from original! Material: ZrO<sub>2</sub> TZP/Vicarbo</i>	 SB15501 SB15502 SB15515 SB15551* SB15535 SB15536	 RB16501 RB16502 RB16515 RB16551* RB16535 RB16536 RB16530 RB16531	 WB17501 WB17502 WB17515 WB17551* WB17535 WB17536 WB17530 WB17531
<b>Docklocs® Abutments (Locator® dental prosthesis)</b> Material: ZrO <sub>2</sub> ATZ, Vicarbo  Suitable for all platforms SB/RB/WB	 SB15542 SB15543 SB15544		
<b>Laboratory auxiliary parts</b> Material: Aluminium, PEEK green, PEEK-CW30	 SB35522 RB36554 RB36521	 RB36522 RB36554 RB36521	 WB37522 RB36554 RB36521
<b>Screw</b> Material: Vicarbo	 RB16550		

**Information:** Further details for orders from page 51.

Docklocs® is a registered trademark of MEDEALIS GmbH, DE.  
 Locator® is a registered trademark of Zest Anchors, Inc., USA.

# The Zeramex XT implant



## The ceramic implant

The Zeramex XT implant: a mile stone in the family of two-piece, reversible screw-in Zeramex ceramic implants. The root-shaped design of the Zeramex XT implant achieves high primary stability. Thanks to the new internal connection, maximum prosthetic flexibility is ensured.



## Hot isostatic post-compacted (HIP) zirconia dioxide ATZ

The Zeramex XT implant is manufactured from hard and hot isostatic post-compacted (HIP) zirconia dioxide ATZ blanks. No thermal process (sintering) or finishing takes place after the final shaping of the outer and inner geometry of the implant. This ensures a high degree of precision and further changes in the material structure are prevented. This manufacturing process is very complex and requires a great deal of experience and know-how.



## “Bolt-in-Tube” – the simple and strong ceramic connection

The “Bolt-in-Tube” connection for Zeramex XT implants provides certainty when taking impressions and for temporary and permanent prosthetic restorations. The design elements of this connection have been selected to provide very high stability, while taking into account the typical material properties of ceramics.

The special geometry with the four interlocks and high precision enables fast and easy insertion and alignment of the abutment.

The core of the connection is the Vicarbo screw. It acts as a bolt, which anchors the abutment in the implant. The extremely hard ceramic is combined with a very stiff, carbon fibre-reinforced high-performance polymer. Similar to reinforced concrete, the ceramic absorbs the compressive forces, while the Vicarbo screw counteracts tensile and bending forces.



# Root-shaped with internal connection

## Prosthetic flexibility

The Zeramex XT implant system offers a high degree of prosthetic flexibility thanks to straight, angled and fully customizable abutments.

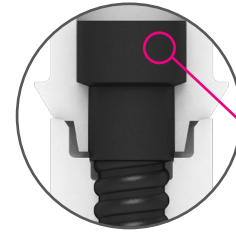

Screw head  $\varnothing$ 2.8 mm

## “Bolt-in-tube”

The “Bolt-in-Tube” connection prevents traction from being exerted on the ceramic. Forces are absorbed by the Vicarbo screw which functions as a bolt.

## Four interlocks

The four interlocks provide precise anti-rotation protection. The “Bolt-in Tube” connection prevents force from being transmitted via the interlocks. These four retaining elements help the abutment to be securely and quickly placed in the implant.

## Internal connection

The four cross-shaped retaining elements provide the ideal torque on insertion so that the implant can be screwed in without stress peaks being exerted on the bone.

## Vicarbo screw

The Vicarbo screw is a precision screw to optimally capture occlusal forces. When tightened, it grips the existing contour of the thread thanks to the significantly different hardnesses of the ceramic and screw.

The **slightly bevelled contact surface** of the implant was developed to facilitate centring and placement of the abutment and auxiliary parts.

## Variable placement depth

The Zeramex XT implant is placed 1.6 mm supracrestal (optional 0.6mm) and offers high prosthetic flexibility.

## Zerafil surface

Excellent osseointegration with the hydrophilic, sandblasted and etched Zerafil surface. Surface treatment up to collar height of 0.6 mm.

## High primary stability

The thread design and cylindrical-conical implant shape achieve high primary stability.

## Reservoir for bone grafts

The reservoir for bone grafts at the implant tip simplifies the placement of the implant.

## Zirconia dioxide ATZ-HIP material

Innovative material for high stress and biocompatibility.

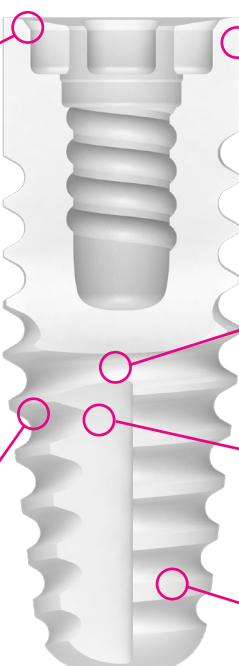
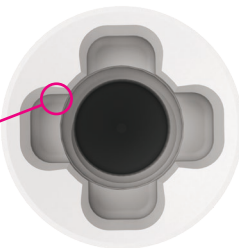
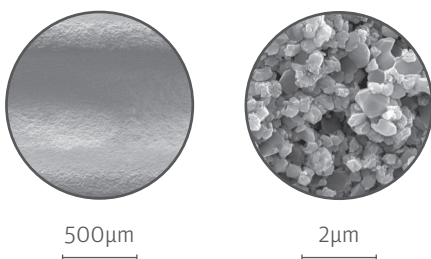

# Case planning in 5 steps

## 1. Preparation phase

As with any surgical procedure, implantation also requires proper professional preparation. Preparation includes a thorough dental and general health examination which includes taking X-ray images and a detailed discussion with the patient regarding their prior medical history. Conventional, prosthetic and periodontal preparatory treatment should be completed before initiating the implant therapy. The options and intentions for later prosthetic restoration (item 5) should be included in the discussion from the start. Use this baseline to work out the individual therapy plan and create a protocol. CT and DVT can be used to gather information about bone conditions which are difficult to diagnose. The bone and its quality decide ultimately on the position and number of implants.

## 2. Implant selection

Implant length and diameter are based on X-ray images. Always use the implant with the largest possible diameter. The vestibular wall thickness must be at least 1 mm, however, to preserve adequate blood circulation. If this is not possible, bone grafting will be necessary.

## 3. Bone preparation

It is essential to follow the drilling protocol starting on page 20. You must provide constant cooling during drilling because temperatures higher than 42 °C may alter bone structure and affect osseointegration!

### Important!

Insert the drill only to the specified marking. The implant is not self-tapping; always use a thread cutter. If the cortical bone is very hard, use the Zeradrill extension. Follow the corresponding drilling protocols. Replace drills after about 20 implantations or in case of reduced cutting performance.

## 4. Implant insertion

We recommend tightening the implant by hand and not tightening at more than 15 rpm. The implant is placed 1.6mm supracrestal, but can optionally be sunk deeper (0.6mm supracrestal). The edge of the implant must be easily accessible in order to correctly tighten the abutment after the initial healing phase. Very good primary stability is important. Use a healing cap to cover the implant after the placement and close the gums. A gingiva former can be used directly in exceptional cases. The minimum required healing period is 3 months for the lower jaw and 6 months for the upper jaw.

### Comply with protocol torque

We recommend a screw-in torque of 20–30 Ncm. The maximum torque for  $\varnothing$ 3.5 mm SB implants is 35 Ncm. For  $\varnothing$ 4.2 mm RB and  $\varnothing$ 5.5 mm WB implants, the maximum torque is 45 Ncm. Never exceed this torque.

## 5. Prosthetic restoration

A range of standard abutments, CAD/CAM abutments, customized abutments and Zeramex Docklocs® abutments for removable prostheses is available for prosthetic restorations. Find out more on page 27 onwards. Prosthetic restoration.

# Distances at bone level

## Distance to adjacent tooth at bone level

A minimum distance of **1.5 mm** between the implant shoulder and the adjacent tooth is required at bone level (mesial and distal).

## Distance to adjacent implant at bone level

A minimum distance of **3 mm** between two adjacent implant shoulders (SB/RB/WB) (mesiodistal) is required.

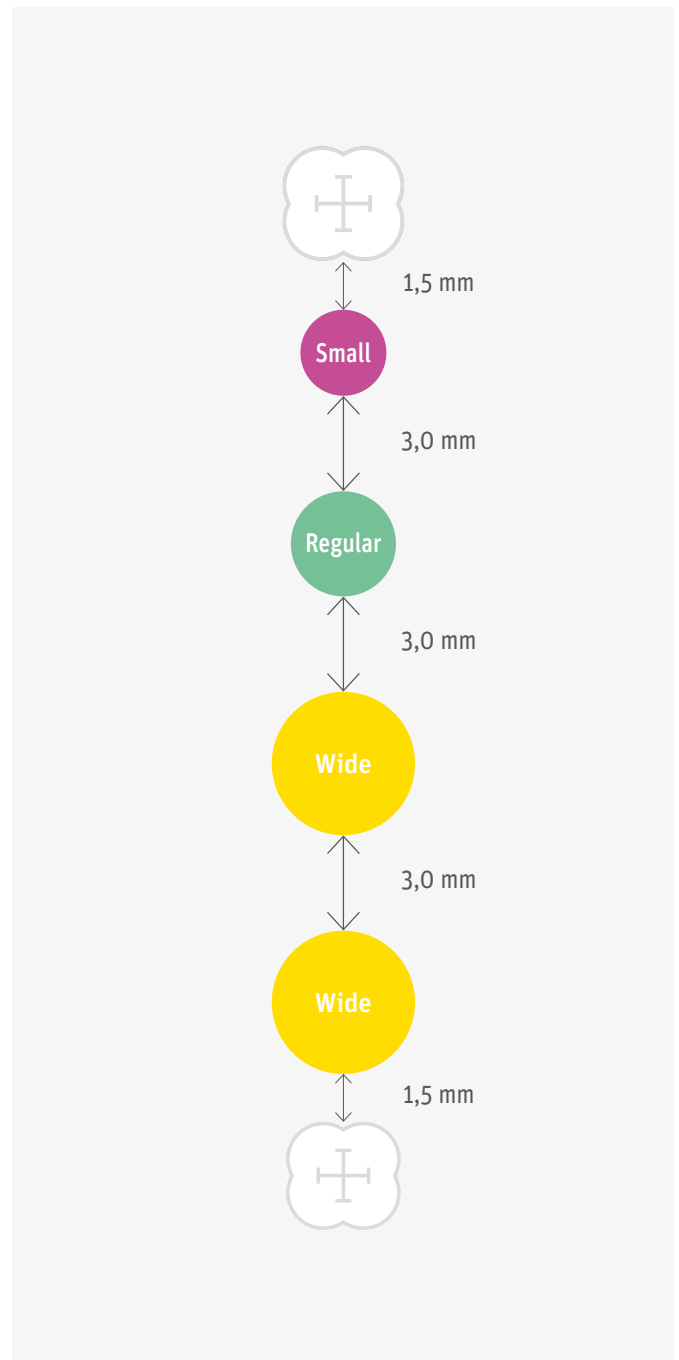

# Surgical tools

XT

## Important!

Follow the corresponding drilling protocols. Replace drills after about 20 implantations or in case of reduced cutting performance.

## Information:

Drillstops are supplied with the tray.

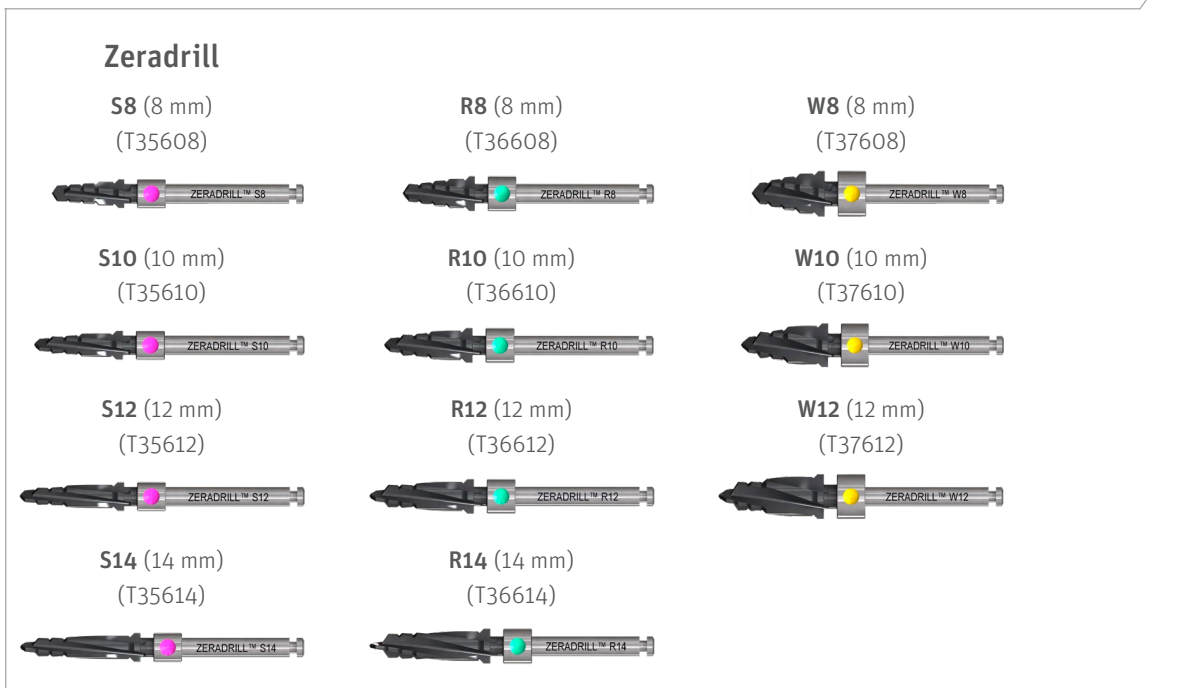
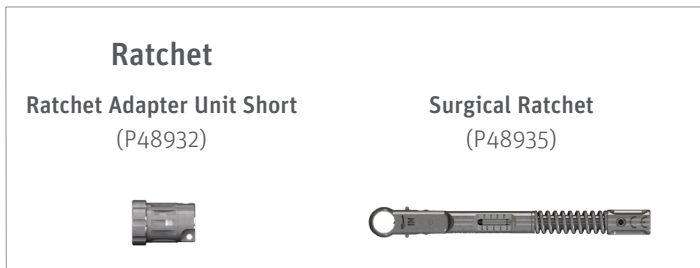
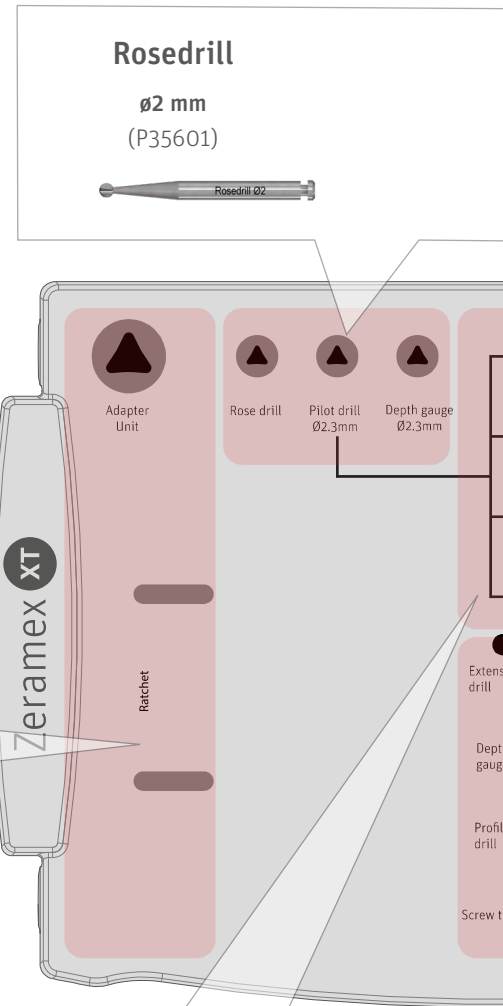
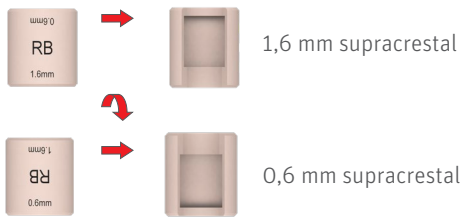



**Zeradrill**

Pilot  $\varnothing 2.3$  mm  
(T35602)



**Depth gauge**

Depth gauge  $\varnothing 2.3$  mm  
(T38650)



\* These slots are reserved for system expansion.

**Extension**

Drill Extension  
(C7650\*)



**Pick-up**

Pick-up (20 mm)  
(XT36620)



Pick-up (25 mm)  
(XT36625)



Rescue Pick-up  
(XT36622)



**Prosthetic key**

Prosthetic key (19 mm)  
(XT38619)



Prosthetic key (23 mm)  
(XT38623)



\*Art. KI589B for Switzerland

**Zeradrill Extension**

Small  $\varnothing 3.5$  mm  
(T35622)



Regular  $\varnothing 4.2$  mm  
(T36622)



Wide  $\varnothing 5.5$  mm  
(T37622)

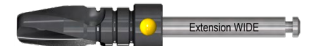

**Profile Drill SB**

Small  $\varnothing 3.5$  mm  
(XT35630)



**Depth gauges**

Small/Regular/Wide  
(T38650)



**Zeratap**

Small  $\varnothing 3.5$  mm  
(T35620)



Regular  $\varnothing 4.2$  mm  
(T36620)



Wide  $\varnothing 5.5$  mm  
(T37620)



# Sterilisation and instrument care

## EN ISO 17664

### Reprocessing of medical devices/general requirements

Refer to the legal and hygiene regulations which are valid for medical office practices and hospitals in your country. This applies in particular to specifications for the effective denaturation of prions. Treatment always involves a risk of contamination and infection. Take preventive measures to actively eliminate the risk or to reduce it as much as possible.

#### These measures include:

- Evaluation of the risks that accompany the medical intervention, decision on appropriate protective measures.
- Development of schematic/systematic procedures for the workflow, in order to prevent contamination and injuries.
- Careful recording of each patient's medical history to be aware of the risk of infection.

All medical devices that have been used, but also opened and laid out for use, are to be considered contaminated and reprocessed hygienically. Organise the transport of these in such a way that no staff members, co-workers or third parties are endangered. All personnel must wear the appropriate protective clothing and gloves.

Medical products may corrode if they are stored in a physiological saline solution. Instruments are to be submerged fully in the sterilisation trays, without air bubbles. The use of demineralised water to rinse instruments after disinfection is absolutely essential to prevent water spots and the formation of crystals. These disrupt the subsequent sterilisation process.

You are responsible for the sterility of the products you use. For this reason, you must only use validated procedures for the cleaning, disinfection, and sterilisation; you must ensure regular maintenance of your equipment, and observe all process parameters in every cycle. Please note the shelf life of products in sterile packaging (manufacturer's data sheet). Reprocessing ends with the release for use. Sterilisation indicator and sterilisation date must be recorded on every sterile packaging.

#### Important!

Products that are delivered in non-sterile condition (e.g. drills and abutments) must be sterilised before they are used on a patient the first time. After use, all reusable medical devices must be reprocessed in accordance with the described procedure.

### Automated reprocessing

For automated cleaning to be effective, it must be preceded by manual cleaning. This removes large impurities (blood, tissue and bone fragments). Rinse instruments under cold, running water immediately after use, and use a fine nylon brush to clean off the large impurities. Then place the instruments in the cleaning tray of your disinfection and cleaning device.

#### Ultrasonic cleaning (optional)

If the instruments are very soiled and it is not possible to remove large impurities manually, cleaning in an ultrasonic bath is recommended. Important: The cleaning agent must be compatible with the products. Please observe the application times and concentrations specified by the manufacturer.

#### Automated cleaning

Only use properly suited cleaning and disinfection equipment for automated cleaning tasks. This should be validated by the user on the basis of established cleaning processes. Place parts in the cleaning tray in accordance with instructions provided by the manufacturer of the equipment. There are commercially available cleaning and disinfection agents. We recommend: "neodisher MediClean" and "neodisher Z" as the neutralising agent (both from Dr. Weigert, Hamburg). Follow the manufacturer's information regarding dosage and use. We recommend fully demineralised water to clean instruments and for the final rinsing procedure. The selected cleaning and disinfection program should run with the optimal temperature for removal of blood (45–55 °C).

#### Example of a cleaning program:

- Pre-rinse with cold water 4 min
- Clean with alkaline cleaning agent at 45–55 °C 10 min
- Neutralisation 6 min
- Intermediate rinse 3 min
- Disinfection 5 min
- Drying (max. 130 °C) 5 min

Before the sterilisation process, check the cleaned, dried and disinfected parts for corrosion and damage.

#### Manual reprocessing

Place the products in a disinfectant solution after use to prevent them from drying out and as a personal protection measure. Remove large impurities (blood, tissue and bone fragments). To do this, take the instruments from the tray and clean them under cold, running water with a fine nylon brush. Never use a metal brush or steel wool for this step!

**Ultrasonic cleaning (optional)**

If the instruments are very soiled and it is not possible to remove large impurities manually, cleaning in an ultrasonic bath is recommended. Important: The cleaning agent must be compatible with the products. Please observe the application times and concentrations specified by the manufacturer.

**Cleaning**

Before cleaning the products, rinse them under a flow of cold, demineralised water. Disassemble all products that can be taken apart. A suitable cleaning agent is, for example, “neodisher MediClean” (Dr. Weigert, Hamburg). Place the products in a fresh cleaning bath, in accordance with the manufacturer’s information. Clean the parts with a nylon brush. Rinse the products several times with demineralised water and check for corrosion or damage.

**Disinfection**

Place the products that need to be disinfected in a fresh disinfectant bath. The liquid must cover them completely. ID 212 instrument disinfection (Dürr System Hygiene) is a suitable disinfectant, for example.

**Rinsing and drying**

After disinfecting the products, rinse thoroughly with demineralised water. Use residue-free compressed air to dry the instruments.

**Sterilisation**

Re-assemble the dismantled medical devices before you start the sterilisation procedure. Sort the separately cleaned and disinfected products into the appropriate sterilisation tray. You may also sterilise products individually.

Then pack the filled trays and/or the individual products in a non-reusable bag suitable for use in a steam steriliser (single or double bags) and/or in a sterilisation container. Bags for use in steam sterilisation processes must meet the specifications of DIN EN ISO 11607 / ANSI/AAMI ST79 / AAMI TIR12:2010.

Examples: a non-reusable sterilisation bag (single or double bag) with temperature tolerance of at least 134 °C (274 °F) and vapour permeability that allows adequate protection from mechanical damage, or else a sterilisation container, which must undergo regular maintenance according to the specifications of the manufacturer.

Instruments such as drills, thread cutters and depth gauges have dedicated positions in the Zeramex XT Surgery Tray (XT48850/XT48854), where they can be placed for sterilisation. Sterilisation is achieved in the autoclave at 132 °C / 270 °F / or 134 °C / 274 °F for the duration of at least 18 minutes holding time and subsequent vacuum drying. The parts should then be marked with a sterilisation date and placed in dry and dust-free storage.

	CE Mark for MDR (2017/745) Class I devices		CE Mark for legacy devices Class IIa / IIb
	CE Mark for MDR (2017/745) Class IIa / IIb devices		Caution
	Article number		Expiry date
	Batch code		Observe the instructions for use
	Do not reuse		Date of manufacture
	Non-sterile		Manufacturer
	Sterilisation by steam or dry heat		Do not use if the packaging is damaged
	Keep away from direct sunlight		
	Keep dry		Medical device
	Unique Device Identifier		EU authorised representative
	Sterile barrier system		Double packaging with single internal sterile barrier
	Do not resterilise		Gamma sterilisation
Rx only	CAUTION: US federal law restricts the sale of this product to a physician or on his or her order.		
	Implant Small ø3.5 mm SB		Implant Regular ø4.2 mm RB
	Implant Wide ø5.5 mm WB		

## Zeramex Implants

### Labelling and colour coding

The implants are colour-coded on the packaging.

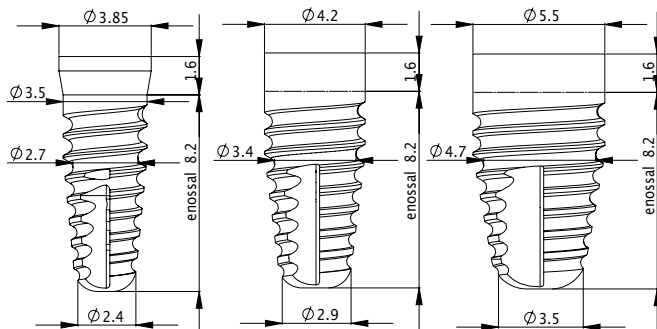

Example of 8 mm implants SB/RB/WB

### Description

The Zeramex XT implant is an innovation in the family of two-piece, reversible screw-retained Zeramex ceramic implants. With the root-shaped design of the Zeramex XT implant, the available space in the jaw can be used in the best possible way.

### Indication

Information on indications is available in the instructions for use (IFU) at [www.zeramex.com](http://www.zeramex.com).

### Material

Zirconia dioxide ATZ, ZrO<sub>2</sub>-ATZ-HIP white

### Order information

#### SB $\varnothing$ 3.5 mm

- XT15508 Zeramex XT  $\varnothing$ 3.5 mm SB, 8 mm (9.8 mm)
- XT15510 Zeramex XT  $\varnothing$ 3.5 mm SB, 10 mm (11.6 mm)
- XT15512 Zeramex XT  $\varnothing$ 3.5 mm SB, 12 mm (13.6 mm)

#### RB $\varnothing$ 4.2 mm

- XT16508 Zeramex XT  $\varnothing$ 4.2mm RB, 8 mm (9.8 mm)
- XT16510 Zeramex XT  $\varnothing$ 4.2 mm RB, 10 mm (11.6 mm)
- XT16512 Zeramex XT  $\varnothing$ 4.2 mm RB, 12 mm (13.6 mm)
- XT16514 Zeramex XT  $\varnothing$ 4.2 mm RB, 14 mm (15.4 mm)

#### WB $\varnothing$ 5.5 mm

- XT17508 Zeramex XT  $\varnothing$ 5.5 mm WB, 8 mm (9.8 mm)
- XT17510 Zeramex XT  $\varnothing$ 5.5 mm WB, 10 mm (11.6 mm)
- XT17512 Zeramex XT  $\varnothing$ 5.5 mm WB, 12 mm (13.6 mm)



# Technical information

## Zerafil surface

### Labelling

Zerafil is available for all Zeramex implants and not specifically labelled.

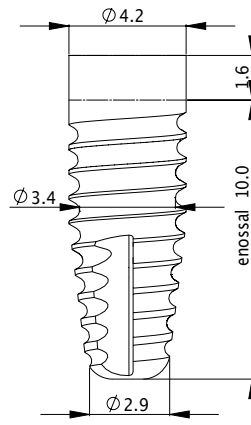

Bsp. 10 mm Implantat RB

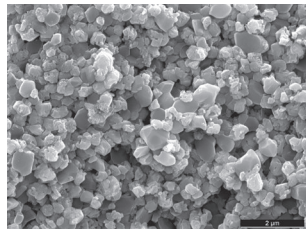
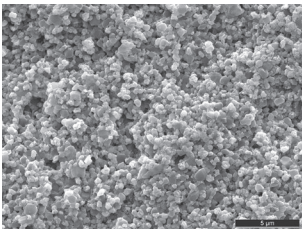
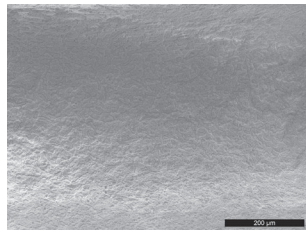
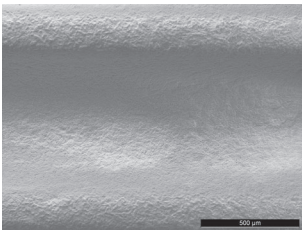

### Description

The Zerafil surface is a micro-structured implant surface that enables optimum, quick and safe osseointegration of the implants.

Blasting with high-grade corundum lends the surface its macrostructure; subsequent acid etching lends it its microstructure, which is key to osseointegration.

Acid etching guarantees a pure implant surface and ensures the required hydrophilic properties.

### Design

The endosseous section of the implant features the Zerafil surface. The neck section (0.6 mm) is polished smooth and not structured with Zerafil.

### Osseointegration

The success rate of Zeramex XT implants with a Zerafil surface is 98 %<sup>1)</sup>, and bears witness to the decisive osseointegration thanks to the optimum surface structure.<sup>2)</sup> The morphology of the hydrophilic Zerafil implant surface supports the migration and attachment of osteoblasts directly on the surface.<sup>3)</sup>

1) Statut janvier 2020, données internes de la surveillance du marché

2) Chappuis V, Cavusoglu Y, Gruber R, Kuchler U, Buser D, Bosshardt DD./Osseointegrazione della zirconia in presenza di cellule giganti multinucleate. 2016

3) Jank S, Hochgatterer G./Success Rate of Two-Piece Zirconia Implants: A Retrospective Statistical Analysis. 2016

## Zeradrill drill

### Labelling and colour coding

The size of the drill is marked on the packaging and the shaft, and appropriate colour coding is applied.

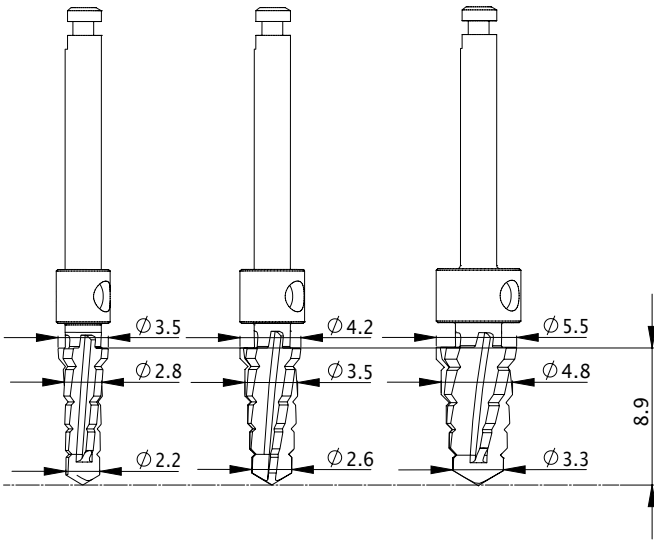

Example of 8 mm drill

### Description

The Zeradrill drill guarantees very good bone preparation for the implant with maximum protection of the surrounding tissue and cells.

The use of hardened medical-grade stainless steel as the base material allows the heat generated by drilling to be efficiently conducted away.

Zeradrill drills are furnished with a pure, metal-free and amorphous carbon coating. This only contains carbon and hydrogen and is therefore 100% metal-free and biocompatible.

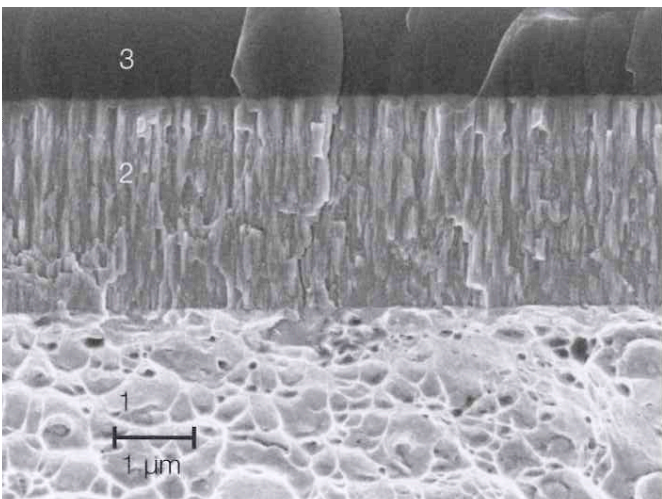

### Material

1. Medical-grade stainless steel
2. Protective layer
3. DLC carbon coating\* (a-C:H)

\*DLC (Diamond-like Carbon) High-performance coating made of diamond-like carbon

# Zeramex XT

## Surgical phase



# Surgical phase

## Planning the insertion depth with the drill stop

### Drill stop

The drill stop allows the drilling depth to be precisely controlled. The drill stop is placed on the drill sleeve. It allows you to insert the implant 1.6mm or 0.6mm supracrestal.

**Note:** Correct position for insertion depth:

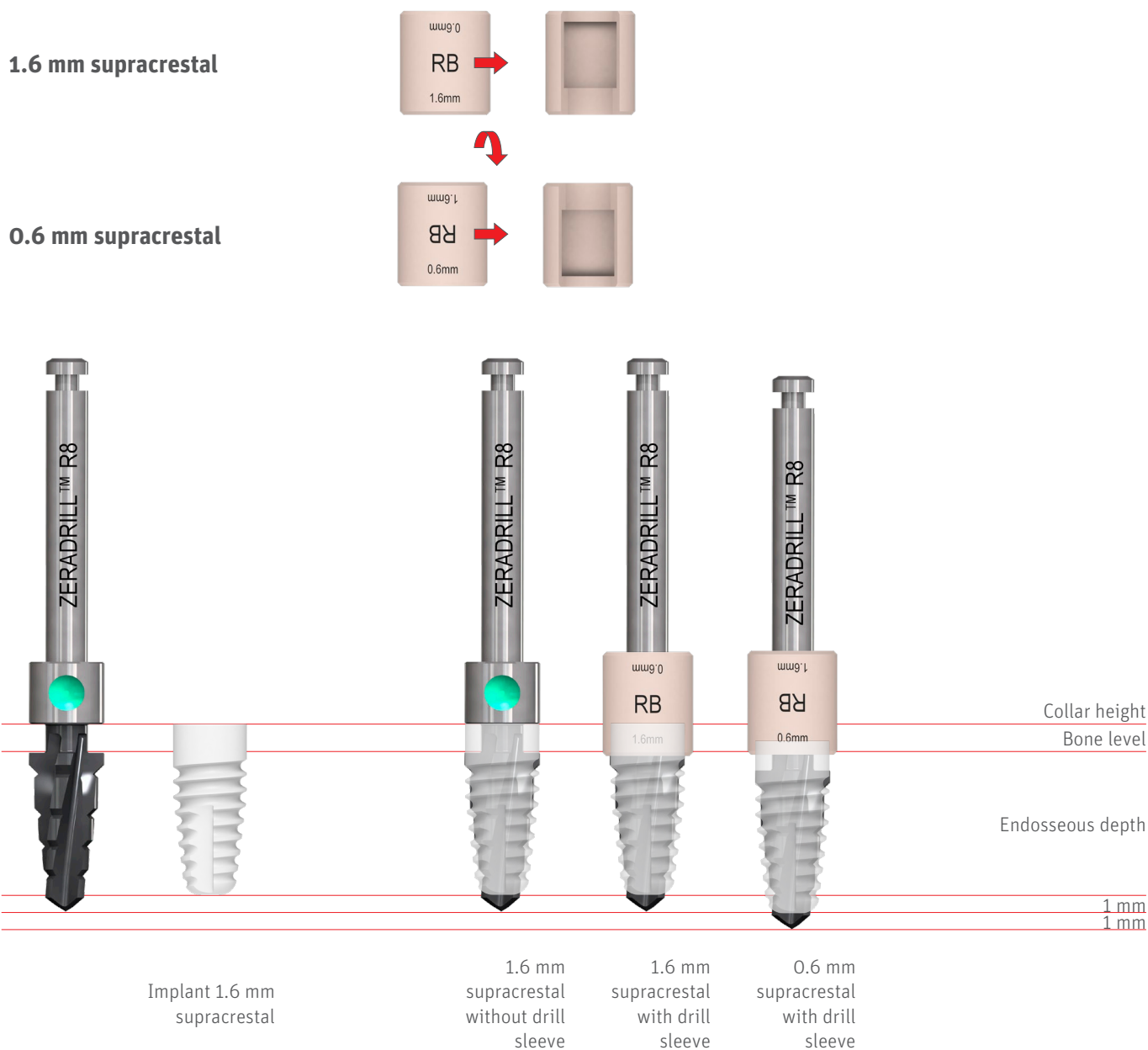



# Surgical phase

## Diameter

The diameter is indicated on each tool by a colour code.



## Depth marks

### Example of implant

Regular  $\varnothing 4.2 \times 8$  mm  
1.6 mm supracrestal

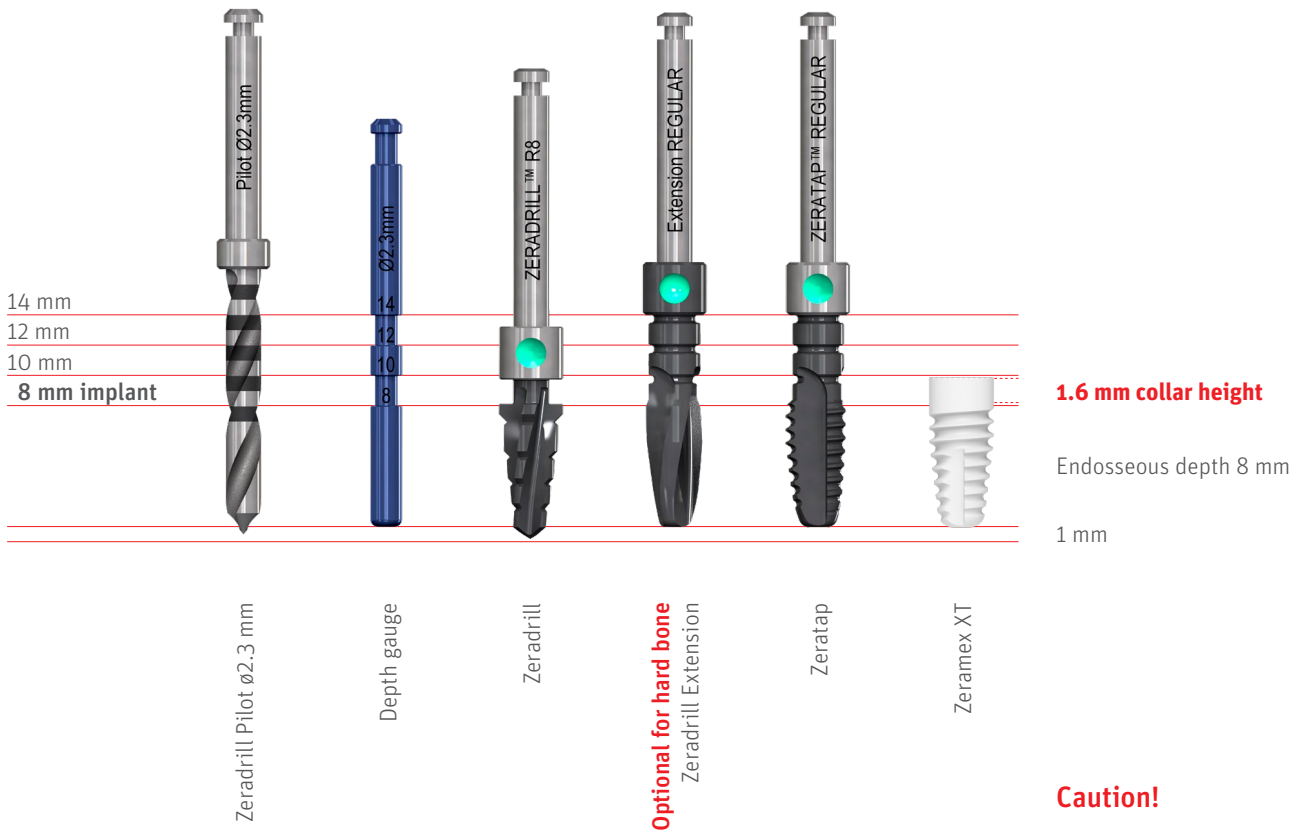

### Caution!

The drilling depth is up to 1mm deeper than the corresponding implant.

## Sterilisation before surgery

Surgical preparation includes steam sterilisation of the surgical tray (surgical instruments) at 132 °C / 270 °F or 134 °C / 274 °F / for: 18 minutes

## Important!

If the drills and instruments are used more than once, place them in the saline solution during the treatment.

# Surgical phase

XT

## Drill tunnel for insertion depth 0.6 mm supracrestal

Optional insertion depth up to **0.6 mm** supracrestal

### Important!

The effective drilling depth is up to 2 mm longer than the defined implant length.

### Example of implant

Regular  $\varnothing 4.2 \times 8$  mm  
0.6 mm supracrestal

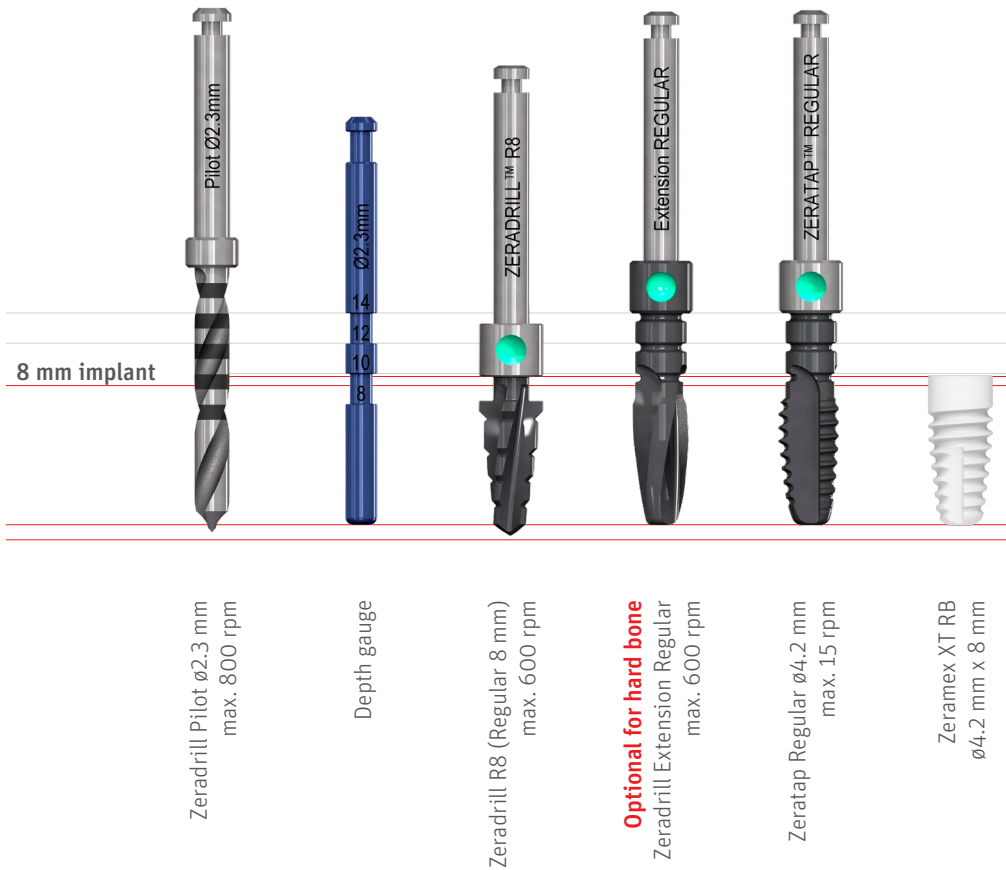

0.6 mm collar height

Endosseous depth 9 mm  
Drill hole depth **10 mm**

1 mm

Zeradrill Pilot  $\varnothing 2.3$  mm  
max. 800 rpm

Depth gauge

Zeradrill R8 (Regular 8 mm)  
max. 600 rpm

**Optional for hard bone**  
Zeradrill Extension Regular  
max. 600 rpm

Zeratap Regular  $\varnothing 4.2$  mm  
max. 15 rpm

Zeramax XT RB  
 $\varnothing 4.2$  mm x 8 mm

Article number	Selected implant length	Pilot Drill drill hole depth	Zeradrill	Extension	Zeratap	Screw-in depth	Effective hole depth
XT15508 XT16508 XT17508	8 mm	9 mm	Up to sleeve	9 mm	9 mm	0.6 mm Supracrestal	10 mm
XT15510 XT16510 XT17510	10 mm	11 mm	Up to sleeve	11 mm	11 mm	0.6 mm Supracrestal	12 mm
XT15512 XT16512 XT17512	12 mm	13 mm	Up to sleeve	13 mm	13 mm	0.6 mm Supracrestal	14 mm
XT16514	14 mm	*	*	*	*	*	*

\* For a length of 14 mm, we recommend that the implant is not placed 0.6 mm supracrestal.

# Surgical phase

## Drill protocol $\varnothing 3.5$ mm SB (1.6 mm supracrestal)

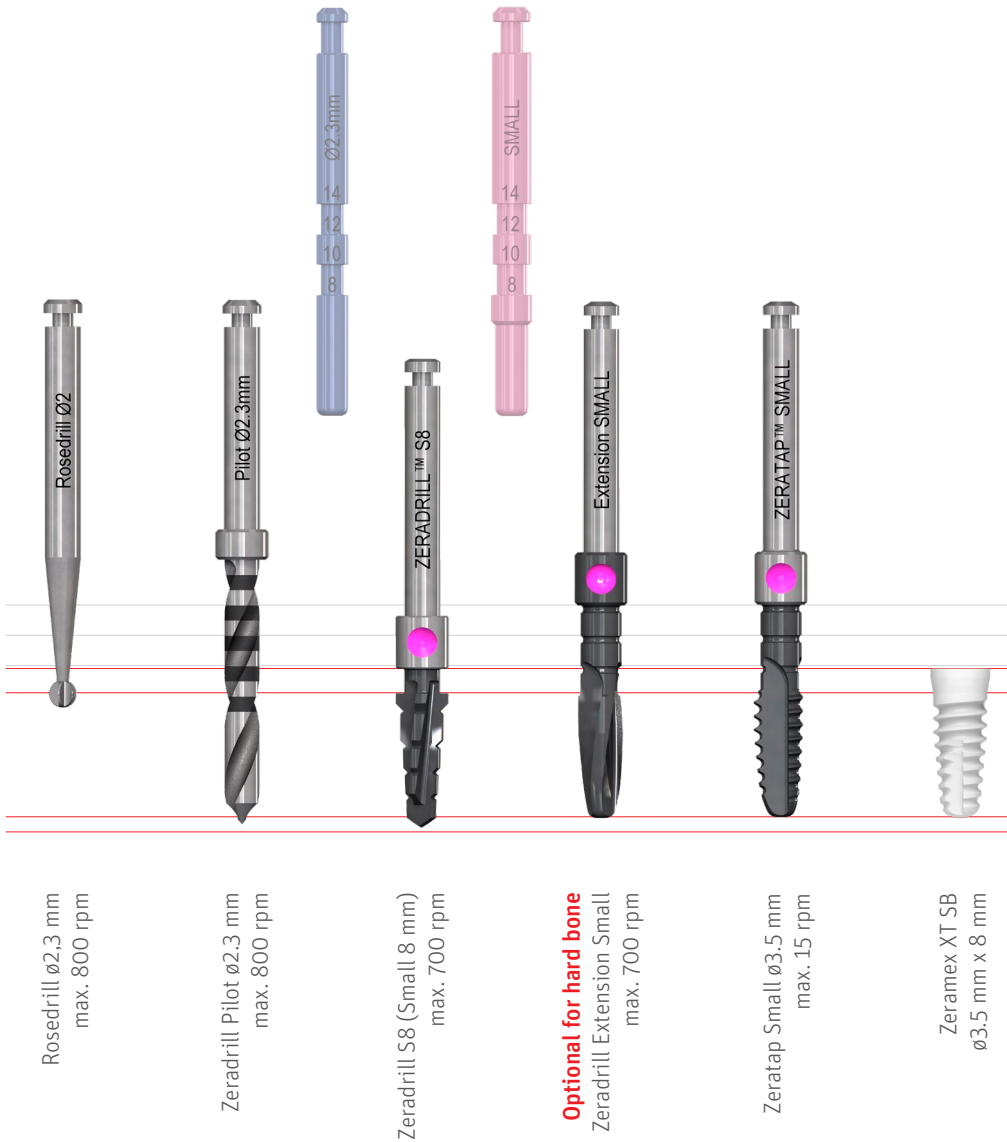

**Attention!** Indications:

- Lateral incisors in the upper jaw
- Anterior teeth in the lower jaw
- Completely for Docklocs for \*removable dentures for 4 implants in the lower jaw and 6 implants in the upper jaw

### Example of implant

Small  $\varnothing 3.5 \times 8$  mm



14 mm  
12 mm  
10 mm

**1.6 mm collar height**

Endosseous depth 8 mm

1 mm

**Note:** Optionally, the implant can also be positioned 0.6 mm supracrestal (instead of 1.6 mm). The drill and thread cutter must be drilled 1 mm deeper in this case.

Endosseous  $\varnothing 3.5$  mm

**Important!**

With  $\varnothing 3.5$  mm implants, do not exceed a torque of 35 Ncm.

**Caution!**

Use the tap according to the bone quality.

\*Our alternative to the LOCATOR® technique

# Surgical phase

XT

## Drill protocol 3.5 mm SB (0.6 mm supracrestal)

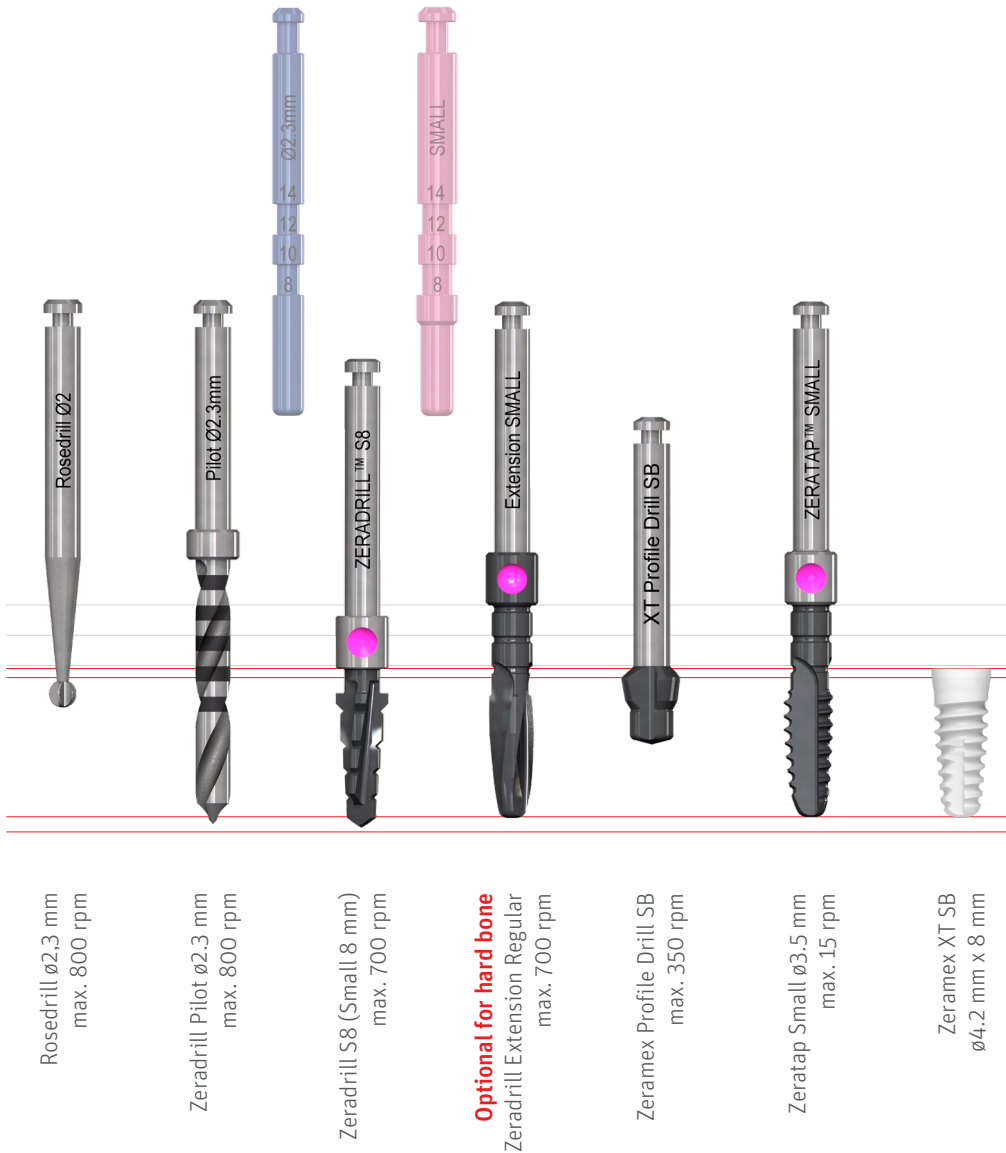

**Attention!** Indications:

- Lateral incisors in the upper jaw
- Anterior teeth in the lower jaw
- Completely for Docklocs for \*removable dentures for 4 implants in the lower jaw and 6 implants in the upper jaw

### Example of implant

Regular  $\varnothing 3.5 \times 8$  mm

SB  
 $\varnothing 3.5$  mm

14 mm  
12 mm  
10 mm

**0.6 mm collar height**

Endosseous depth 9 mm

1 mm

**Note:** If the implant is placed 0.6 mm supracrestal, the drill and thread cutter must be drilled 1 mm deeper. A profile drill (XT35630) is also required.

Endosseous  $\varnothing 3.5$  mm

SB  
 $\varnothing 3.5$  mm

### Important!

With  $\varnothing 3.5$  mm implants, do not exceed a torque of 45 Ncm.

### Caution!

Use the tap according to the bone quality.

\*Our alternative to the LOCATOR® technique

# Surgical phase

## Drill protocol $\varnothing 4.2$ mm RB

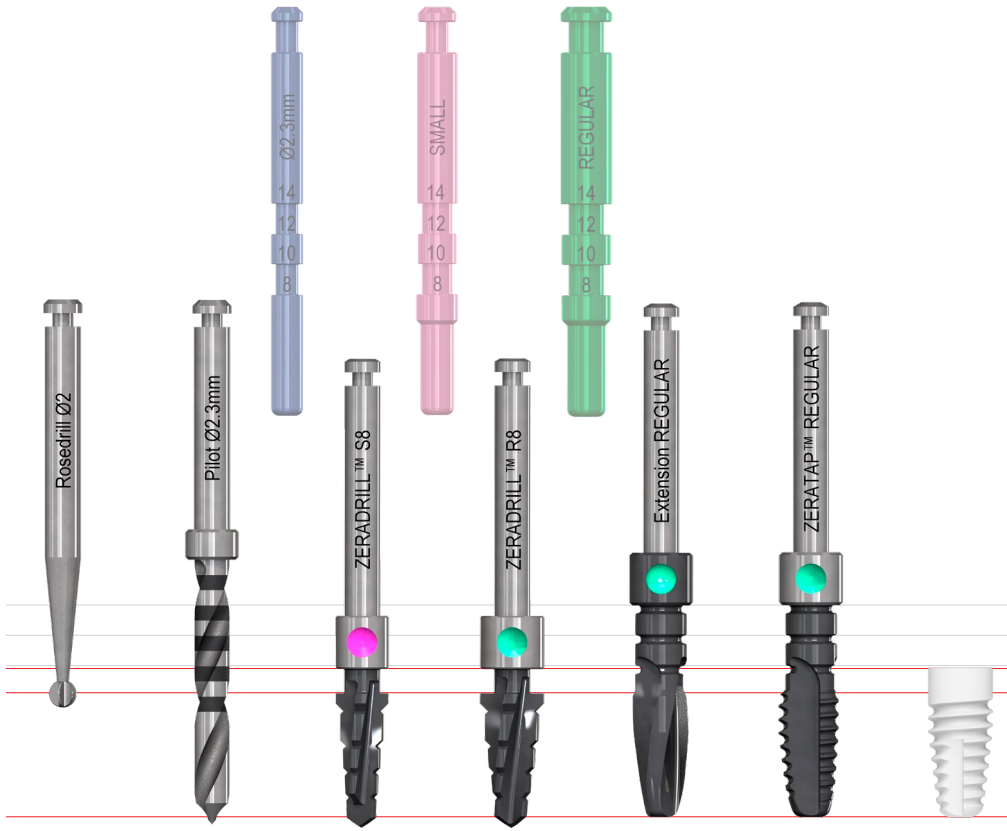

### Example of implant

Regular  $\varnothing 4.2 \times 8$  mm



14 mm  
12 mm  
10 mm

**1.6 mm collar height**

Endosseous depth 8 mm

1 mm

Rosedrill  $\varnothing 2.3$  mm  
max. 800 U/min

Zeradrill Pilot  $\varnothing 2.3$  mm  
max. 800 U/min

Zeradrill S8 (Small 8 mm)  
max. 700 U/min

Zeradrill R8 (Regular 8 mm)  
max. 600 U/min

**Optional for hard bone**  
Zeradrill Extension Wide  
max. 600 U/min

Zeratap Wide  $\varnothing 4.2$  mm  
max. 15 U/min

Zeramex XT RB  
 $\varnothing 5.5$  mm x 8 mm

**Note:** Optionally, the implant can also be positioned 0.6 mm supracrestal (instead of 1.6 mm). The drill and thread cutter must be drilled 1 mm deeper in this case.

Endosseous  $\varnothing 4.2$  mm



### Important!

With  $\varnothing 4.2$  mm implants, do not exceed a torque of 45 Ncm.

### Caution!

Use the tap according to the bone quality.

# Surgical phase

XT

## Drill protocol $\varnothing 5.5$ mm WB



Rosedrill  $\varnothing 2$  mm  
max. 800 U/min

Zeradrill Pilot  $\varnothing 2.3$  mm  
max. 800 U/min

Zeradrill S8 (Small 8 mm)  
max. 700 U/min

Zeradrill R8 (Regular 8 mm)  
max. 600 U/min

Zeradrill W8 (Wide 8 mm)  
max. 500 U/min

**Optional for hard bone**  
Zeradrill Extension Wide  
max. 500 U/min

Zeradrill Wide  $\varnothing 5.5$  mm  
max. 15 U/min

Zeramex XT WB  
 $\varnothing 5.5$  mm x 8 mm

### Example of implant

Wide  $\varnothing 5.5 \times 8$  mm



14 mm  
12 mm  
10 mm  
1.6 mm collar height

Endosseous depth 8 mm

1 mm

**Note:** Optionally, the implant can also be positioned 0.6 mm supracrestal (instead of 1.6 mm). The drill and thread cutter must be drilled 1 mm deeper in this case.

Endosseous  $\varnothing 5.5$  mm

WB  
 $\varnothing 5.5$  mm

### Important!

With  $\varnothing 5.5$  mm implants, do not exceed a torque of 45 Ncm.

### Caution!

Use the tap according to the bone quality.

# Surgical phase

## Handling



1.

**1. Contents**  
Box contents: Implant in a spherical packaging with matching healing cap.

**Important!**  
Check the required implant dimensions before opening the package.

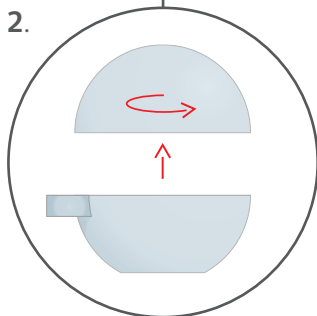

2.

**2. Open sphere**  
Open the sphere by twisting.

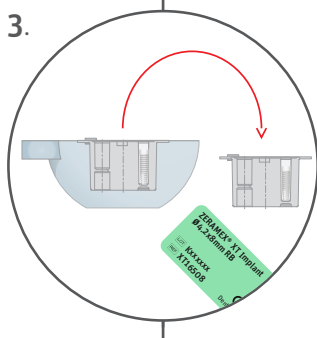

3.

**3. Remove**  
Remove the sterile secondary blisters (low microbial contamination) and patient labels from the sphere.

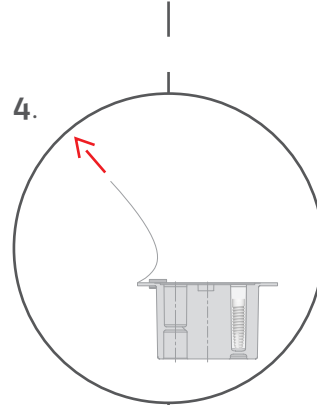

4.

**4. Open blister**  
Break the seal shortly before use (interior is sterile).

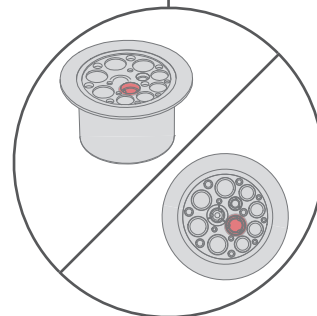

5.

**Important!**  
The healing cap designed to match the implant is also included in the sterile secondary blister in the designated cavity.



**5. Pick up implant**  
Pick up the implant using the pick-up tool (insert in the ratchet adapter; snap in the square socket). It is recommended to put the Healing Cap on the sterile area and to pick up the implant using the prosthetic key or pick-up.

**Required material**  
**Pick-up** (XT36620/XT36625),  
**Ratchet Adapter Unit Short** (P48932)



# Surgical phase

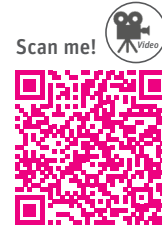

## Implant

### Insert

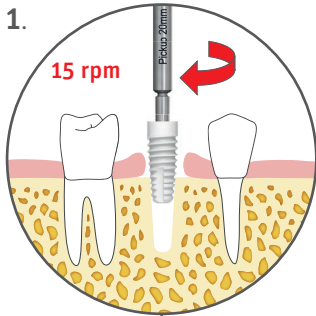

**1. Screw in**  
Slowly screw the implant into the pre-cut drill hole.

**Important!**  
Never use the rescue pick-up for insertion.

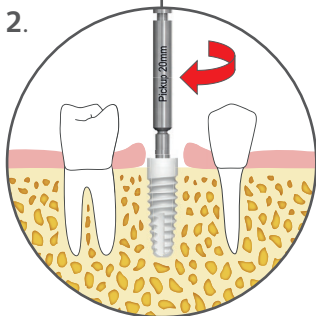

**2. Tighten**  
Tighten the implant using the ratchet.  
Recommendation: 20 - 30 Ncm  
**SB max. 35 Ncm**  
**RB/WB max. 45 Ncm**

**Important!**  
Due to the conical design, torque is only exerted in the last two rotations.

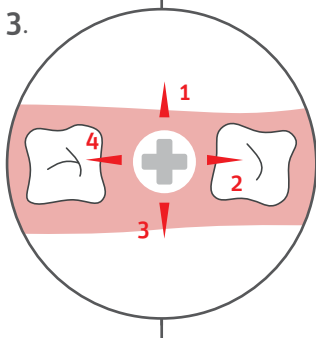

**3. Positioning**  
◀ = The arrows show the possible positions of the angled abutment. Take this into account when inserting the implant.

### Seal

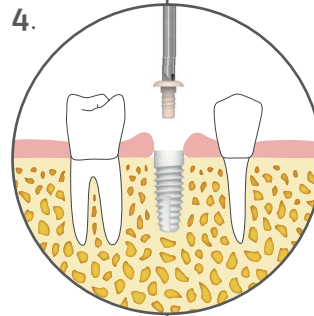

**4. Seal**  
Seal the implant with the healing cap using the prosthetic key (XT38619/XT38623/XT38628) and carefully tighten the healing cap (**max. 5 Ncm**).

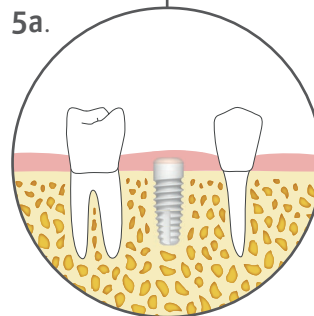

**5a. Version 1**  
Closed healing (recommended).

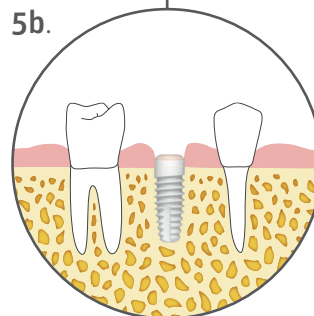

**5b. Version 2**  
Open healing; note closely adjacent gingiva.

**Comply with protocol torque**  
The maximum torque for all SB implants is **35 Ncm**. The maximum torque for RB and WB implants is **45 Ncm**. Never exceed this torque. The pick-up has a predetermined breaking point of approximately 50 Ncm. Maximum speed: **15 rpm**.

# Zeramex XT

## Prosthetic restoration



## Gingiva former

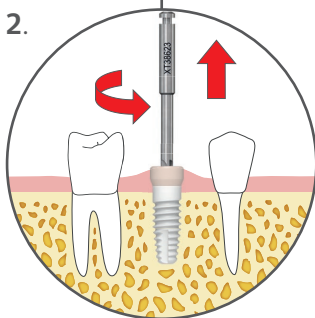
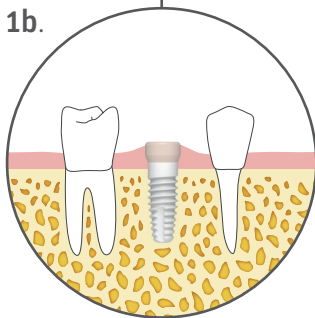
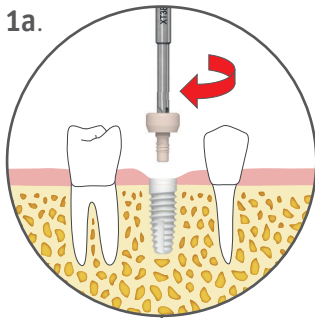

### Comply with protocol torque

Force does not need to be applied to insert the gingiva former. Carefully screw in to the full depth.

### 1a/b. Insert

Place the gingiva former on the prosthetic key and carefully screw in clockwise to the full depth under slight pressure. (max. 5 Ncm).

### 2. Remove

To remove the gingiva former, insert the prosthetic key and turn counterclockwise.

### Required material

**Gingiva former** (SB35503/SB35504/RB36503/RB36504/WB37503/WB37504),  
**Prosthetic key** (XT38619/XT38623/XT38628)

## Temporary restoration

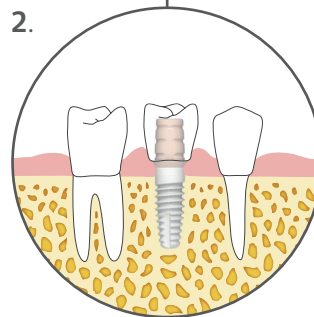
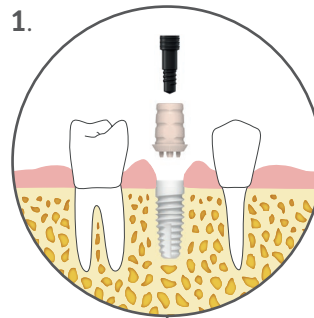

### 1. Position

Position the temporary abutment and tighten with the prosthetic key (max. 15 Ncm).

### Important!

The maximum wearing time of the temporary abutment is **180 days**.

### General information

Bear in mind that polymer prosthetic components have a different feel than metal to the user. Familiarise yourself with this beforehand.

### 2. Process

If necessary, work on the provisional extra-orally and provide it with a provisional crown.

### Processing the provisional restoration

It is preferable to machine the polymer with fine-grain diamond-coated instruments at a high speed. This is done extra-orally with slight pressure and effective cooling.

### Required material

**Provisional restoration** (SB35530/RB36530/WB37530),  
**Prosthetic key** (XT38619/XT38623/XT38628)

# Digital impression taking

## Intraoral scan

### In the surgery

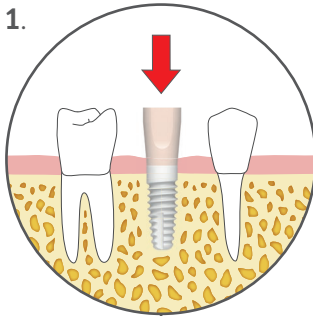

1.

#### 1. Positioning

Thoroughly clean the implant connection. Place the corresponding scan abutment (Scanbody SB/RB/WB) on the implant and ensure that the surface is clearly visible to the scanner during positioning.

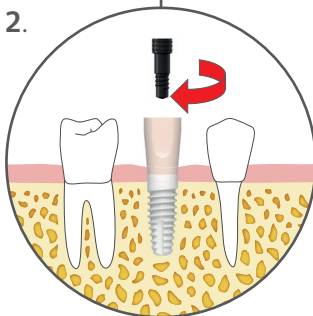

2.

#### 2. Screw tight

Tighten the scan abutment (Scanbody SB/RB/WB) with the corresponding screw (**max. 5 Ncm**) and ensure it is firmly in place.

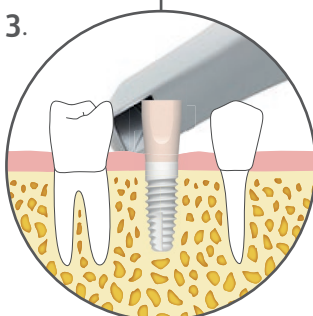

3.

#### 3. Taking an impression

Perform the scanning procedure according to the instructions of the system used. Send digital scan data to the laboratory to create the 3D print model with associated analogue cavity.

#### Information!

Alternatively, a master model can also be digitised in a 3D laboratory scanner for further processing.

#### Information!

Method suitable for common CAD/CAM systems.

### In the laboratory

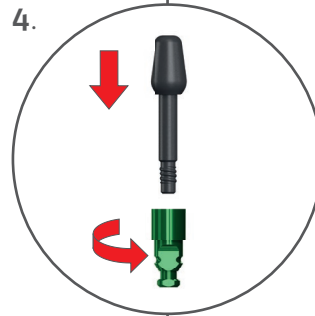

4.

#### 4. Connecting

Screw in the Digital Implant Replica Placer (insertion instrument) by hand in a clockwise direction.

#### Important!

Check the analogue cavity in the print model for structural defects and residues.

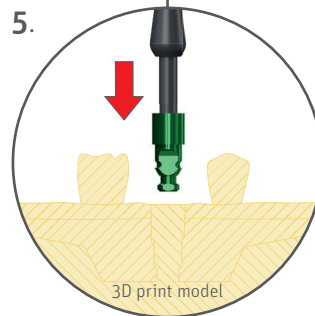

5.

#### 5. Fitting

Insert and centre the Digital Implant Replica into the cavity. Then press the Digital Implant Replica down with sufficient pressure until it clicks into place. The basally visible surface should be flush with the print model. Check Digital Implant Replica for tight fit.

#### Important!

Repeated removal and insertion of the replica in the same model may cause wear to the snap-in function.

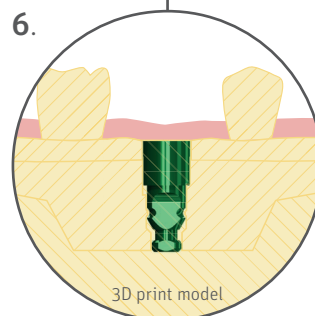

6.

#### 6. Restoration

The individual secondary part for occlusal screwed restorations (from page 36) is available for the digital workflow. Digital scan data can be processed directly in exocad and 3Shape software (complete integration).

#### Required material

Scanbody incl. Screw (SB35514/RB36514/WB37514), Digital Implant Replica Placer (RB36521), Digital Implant Replica (SB35522/RB36522/WB37522)

# Conventional impression taking

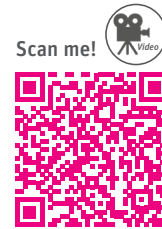

XT

## Open tray

### In the surgery

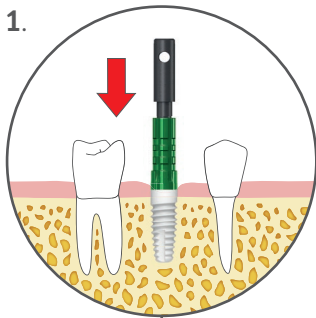

**1. Position**  
Place the locking pin with the transfer sleeve on the implant shoulder under slight pressure while turning until it snaps into the hex head socket, rests securely on the implant shoulder, and can no longer be rotated.

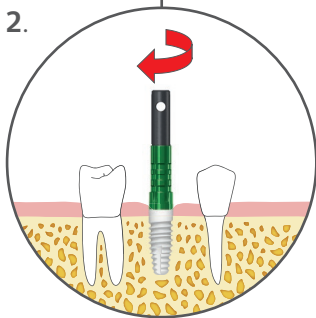

**2. Screw tight**  
Secure the transfer sleeve with one hand. Tighten the locking pin clockwise by hand, and check the position for a form-fit. In case of doubt, take an X-ray.

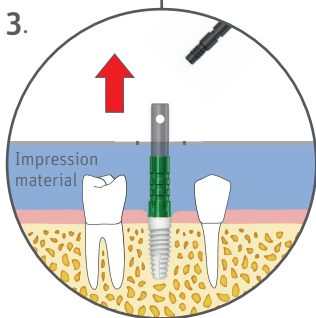

**3. Taking an impression**  
Create the impression with an open tray. Unscrew and remove the locking pin. Remove the impression and send with the locking pin to the dental technician.

**Important!**  
The transfer sleeves must be snapped into the inner edge and mate securely. To check, apply a slight counter-movement.

### Information!

The four **retaining elements** of the implant must be correctly aligned when selecting an **angled abutment** (User Instructions Surgery, page 26, fig. 3), otherwise we recommend using a **customized abutment** instead (page 42).

### In the laboratory

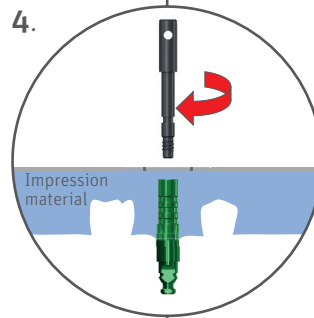

**4. Connecting**  
Position the transfer sleeve on the replica shoulder under slight pressure while twisting until it snaps into the hex head socket of the digital implant replica, rests securely on the shoulder and can no longer be rotated. Tighten the locking pin clockwise by hand.

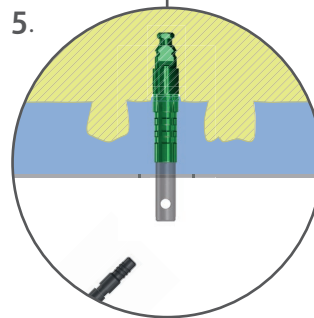

**5. Creating model**  
Check that the transfer with the screw-fitted digital implant replica is securely seated. Create master model. Remove the locking pin before removing the impression.

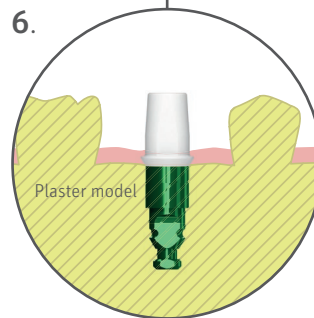

**6. Restoration**  
Select an abutment based on the prosthetic requirements and the preferred surgical method. Straight and angled abutments, CAD/CAM and customized abutments are available, along with Zeramex Docklocs® Abutments (from page 49).

### Required material

**Transfer Open Tray** (SB35510/RB36510/WB37510), **Digital Implant Replica** (SB35522/RB36522/WB37522)



# Conventional impression taking

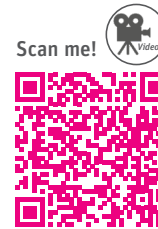

## Closed tray

### In the surgery

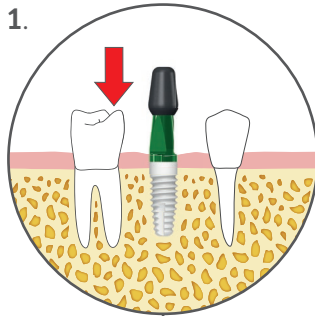

#### 1. Positioning

Place the transfer sleeve on the implant shoulder under slight pressure while turning until it snaps into the hex head socket, rests securely on the implant shoulder, and can no longer be rotated.

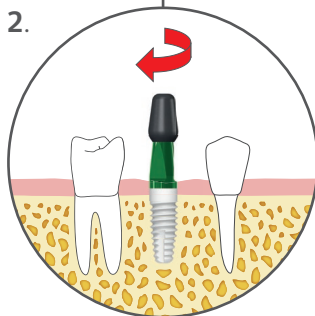

#### 2. Tighten

Tighten the locking pin clockwise by hand, and check the position for a form-fit.

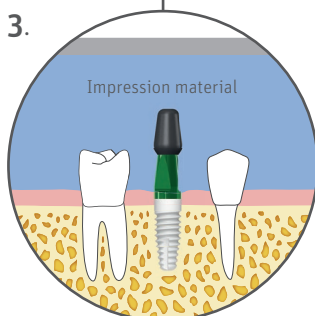

#### 3. Taking an impression

Take an impression with a closed tray and remove. Unscrew the locking pin, remove the transfer from the implant and send to the dental technician with the impression.

### In the laboratory

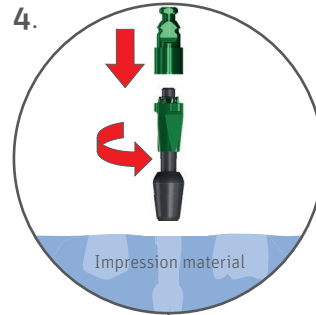

#### 4. Connecting

Position the transfer sleeve on the replica shoulder under slight pressure while twisting until it snaps into the hex head socket of the digital implant replica, rests securely on the shoulder and can no longer be rotated. Tighten the locking pin clockwise by hand.

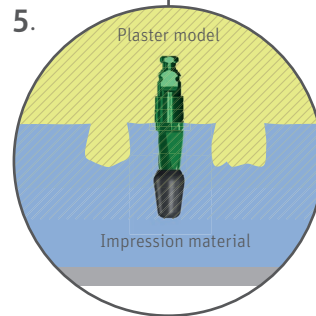

#### 5. Repositioning and creating model.

Reposition the transfer with the screw-fitted digital implant replica and check that it is securely seated. Create master model.

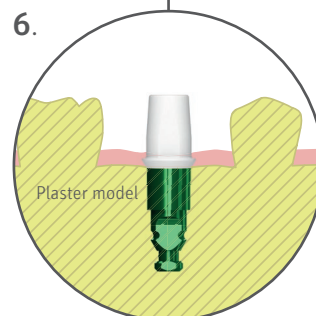

#### 6. Restoration

Select an abutment based on the prosthetic requirements and the appropriate surgical method. Straight and angled abutments, CAD/CAM and customized abutments are available, along with Zeramex Docklocs® Abutments (from page 49).

### Important!

The transfer sleeves must be snapped into the inner edge and mate securely. To check, apply a slight counter-movement.

### Caution!

Closed impression taking is not recommended for the front section of the maxilla or in the case of angulation greater than 15°.

### Required material

Transfer Closed Tray (RB36512/WB37512) or (RB36513/WB37513), Digital Implant Replica (SB35522/RB36522/WB37522)

# Prosthetic process

## Field of use

Information on fields of use and indications is available in the instructions for use (IFU) at [www.zeramex.com](http://www.zeramex.com).

### 1 Preparation phase

Prosthetic restoration is governed by the overall approach for achieving the best possible results. Integral functionality, aesthetics and patient comfort are the primary considerations. A detailed dental analysis (including X-rays) taking into account the patient's medical history is the foundation for this. Create the treatment plan based on the main considerations.

### 2 Gingiva management

A “pink” appearance reflects healthy gums. It is essential to treat any gum disorders in advance. Soft tissue grows well around zirconia oxide, which is of great relevance, especially in the anterior region. A natural emergence profile is individually created using a gingiva former or a provisional, and the “black triangle” is a thing of the past.

### 3 Abutment/implant connection

There are two basic pathways to metal-free, aesthetically and biologically flawless restoration:

- Screwed prosthetic restoration (page 34)
- Cemented prosthetic restoration (page 38)

The range of metal-free prosthetics is extensive and satisfies the stringent requirements with regard to aesthetics and functionality. The Zeramex XT implant with its various abutments is ideal for nearly every situation.

### 4 Workflow

The Zeramex XT implant system seamlessly integrates with conventional procedure using manual, direct and indirect impressions.



The prosthetic parts marked pink are for the SB platform (3.5 mm implant).



The prosthetic parts marked green are for the RB platform (4.2 mm implant).



The prosthetic parts marked yellow are for the WB platform (5.5 mm implant).

**Note:** The exceptions are the screws (RB16550/RB36554/RB36550/RB36514). Please note the information on pages 48-50.



Vicarbo  
Screw  
RB16550

Try-In  
Screw  
RB36554

Provisional  
Screw  
RB36550



# Prosthetic tools

**Important!**

Products must be secured against aspiration when handled intraorally!



**Ratchet**

**Important!**

Always store the ratchet untightened.

Surgical Ratchet (P48935)



Adapter Unit Short (P48932)



**Prosthetic key**

Prosthetic key 19 mm (XT38619)



Prosthetic key 23 mm (XT38623)



Prosthetic key 28 mm (XT38628)



**Prosthetic kit**

Prosthetic kit (XT48860)

Prosthetic kit, incl. Ratchet (XT48865)

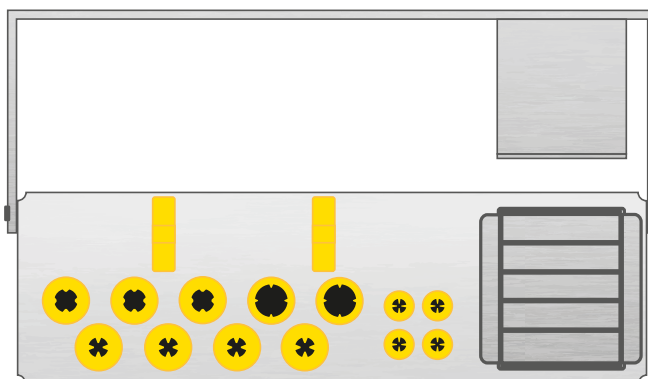

# Screwed connection

SB  
ø 3.5 mm

RB  
ø 4.2 mm

WB  
ø 5.5 mm

## Abutments

Straight (in two collar heights) and angled abutments are available for the implants 3.5 mm (SB), 4.2 mm (RB) and 5.5 mm (WB).

1 mm  
Straight



2 mm  
Straight



1 mm  
Angular



## Vicarbo screw

The strong screw made of high performance polymer reinforced with carbon fibre.

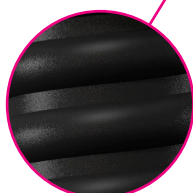

## Digital Workflow

**Zerabase/Zerabase X:** The individually shaped abutment for occlusal screwed restorations. Integration in exocad and 3Shape software.

**Customized abutment:** Your Zeramex Digital Solutions competence centre for digital and individual prosthetic solutions - customized from A-Z.

Zerabase X

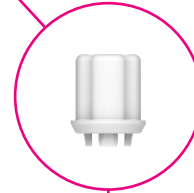

Zerabase

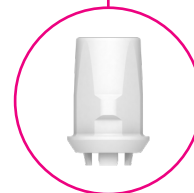

Customized  
abutment

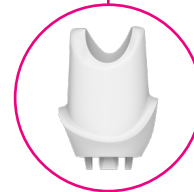

exocad

3shape

# Screwed prosthetic restoration

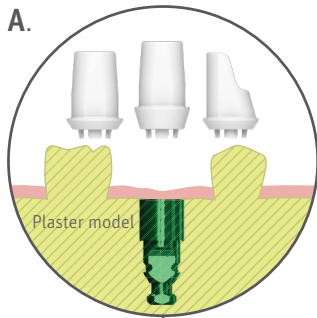

**A.** Select the suitable abutment.

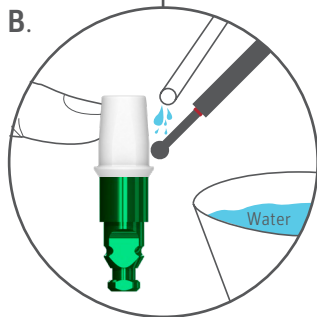

**B.** If necessary, individually machine the abutment. Only process the abutment under sufficient, continuous cooling with slight pressure. Local overheating causes micro-fissures and destruction of the abutment.

**Important!** Please note the information on machining abutments on page 47!

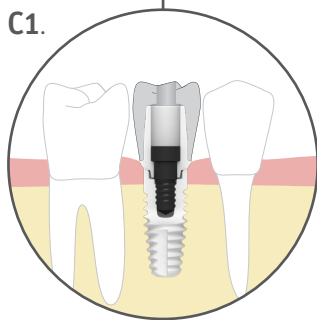

**C.** All XT abutments are approved for the following: Adhesion, milling and pressing. You can choose a monolithic crown (C1) or a full-ceramic crown on a zirconia dioxide cap (C2).

**C1.** Monolithic crowns made of various optimised polymers or zirconia dioxide.

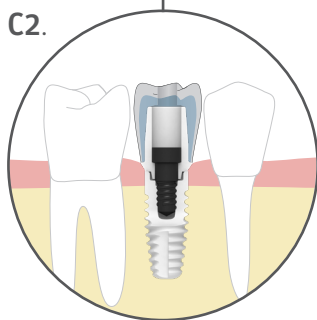

**C2.** All-ceramic crowns made of layered or pressed ceramic on a zirconia dioxide cap.

## Fabricating supraconstructions in the laboratory

The Zeramex XT system offers reversible screwing into zirconia dioxide. The internal thread makes it possible to screw prosthetic parts and zirconia dioxide abutments into implants. The anti-rotation protection on the platform allows secondary parts to be securely and precisely positioned, and the laboratory screw ensures that they are firmly seated.

### Everything you need for the laboratory at a glance

- Every abutment is supplied with the appropriate Vicarbo screw.
- Every Vicarbo screw may only be tightened once up to the maximum torque.
- The torque for the **Vicarbo screw** for the SB/RB/WB platform is always **25 Ncm!**
- For work in the laboratory, we offer **Try-In Screws** that may not be tightened more than **5 Ncm.**
- Adapt your approach to the anatomical situation and do not use over-dimensioned crowns or connections to natural teeth (hybrid restoration).
- Do not use “floating crown attachments” with an abutment.
- When grinding the abutment, an additional replica can be used as a holder. Counterpressure with the fingers reduces vibration.

**Tip:** Use an individual positioning wrench for angled abutments or complex restorations

Scan me! 



### Important!

It is essential to consider the minimum layer thickness according to the manufacturer’s instructions for the specific crown material.

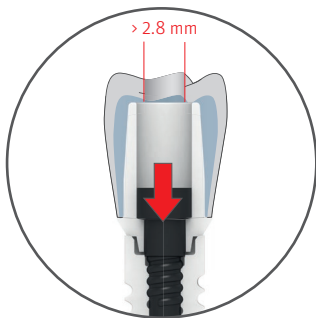

The diameter of the screw channel for the Vicarbo screw for the **SB/RB/WB platform must be > 2.8 mm.**



The diameter of the screw channel for the reduced-diameter version must be **> 2.2 mm.**

### Caution!

When sealing the screw channel, do not use any gels or liquids containing chlorine.

## Occlusal screwed connection in the patient's mouth

### Restoration with placeholders

When using placeholders, make sure that the screw channel diameter allows the Vicarbo screw to be inserted into and removed from the abutment and crown at any time, even when the crown is already tightly cemented to the abutment.

You can make your own positioning aids/placeholders:  
**SB/RB/WB platform: > 2.8 mm**

### Screw channel with a reduced diameter

You can also use screw channels with a reduced diameter instead of placeholders. With this, the screw channel diameter can be reduced to **> 2.2 mm**. The prosthetic key (XT38619/XT38623/XT38628) can be used as a placeholder.

### Important!

- When using reduced-diameter screws, the Vicarbo screw must be inserted in the abutment in the laboratory before the crown is secured onto the abutment.
- The Vicarbo screw cannot be screwed in or out after the crown has been cemented.
- When cementing the crown, excess cement must not enter the screw channel of an inserted screw (insert cotton wad or a similar placeholder that can be removed from the screw channel).
- If the abutment is shortened, make sure that the Vicarbo screw has sufficient vertical space to be screwed in and out.

# Screwed prosthetic restoration

## Comply with protocol torque

The unique torque for the Vicarbo screw for all platforms is **(SB/RB/WB): 25 Ncm.**

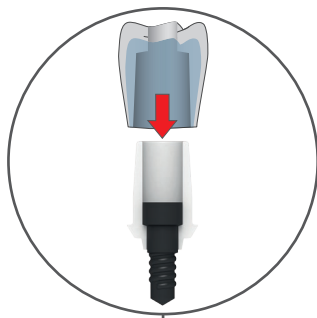

1a.

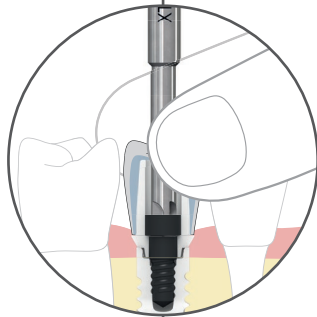

1b.

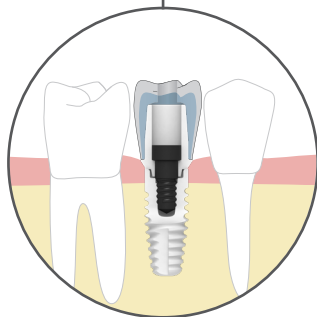

## Occlusal screwed connection in the patient's mouth

### 1a.

The cap can be veneered by pressing or layering. Select the diameter of the screw channel for later screwing depending on the procedure:

- SB/RB/WB abutments: > 2.8 mm
- **Reduced diameter: > 2.2 mm\***

### \*Important!

When using reduced-diameter screws, the screw must be inserted in the abutment before the crown is cemented onto the abutment. Please note the information on page 36.

### 1b.

Place the abutment with the cemented crown on the implant. Apply slight pressure to fit the abutment/crown until it snaps into place in the correct position. Hold the abutment/crown and tighten the screw in the screw channel by applying pressure from the occlusal direction. **Use the prosthetic key and the torque ratchet (SB/RB/WB: 25 Ncm).** Use a probe and/or X-ray to check if the abutment is correctly seated.

### Required material

**Abutment incl. Vicarbo screw** (SB15501/SB15502/SB15515), (RB16501/RB16502/RB16515), (WB17501/WB17502/WB17515), **Zerabase X/Zerabase incl. Vicarbo screw** (SB15535/SB15536), (RB16535/RB16536/RB16530/RB16531), (WB17535/WB17536/WB17530/WB17531), **Customized abutments** (SB1551),(RB16551),(WB17551), **Prosthetic key** (XT38619/XT38623/XT38628)

# Cemented prosthetic restoration

## Comply with protocol torque

The unique torque for the Vicarbo screw for all platforms is **(SB/RB/WB): 25 Ncm.**



2a.

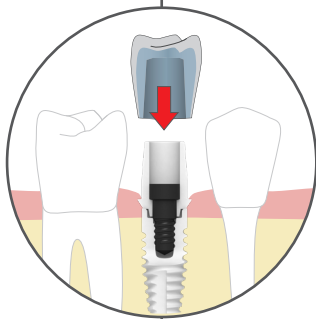

2b.

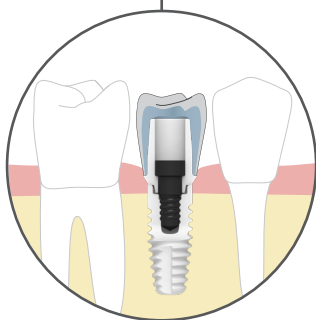

## Cementing the crown in the patient's mouth

**Note:** If a screw channel is not possible or required, the crown can be produced in the laboratory without a screw channel.

### 2a.

The Vicarbo screw is picked up with the prosthetic key and inserted into the abutment. The abutment can now be transferred onto the implant with the prosthetic key.

**Note:** Hold the abutment and screw tight > No locking! Before tightening the screw, press it downward. Use the prosthetic key and the torque ratchet to tighten the screw. **(SB/RB/WB: 25 Ncm).** Use a probe and/or X-ray to check if the abutment is correctly seated.

**Note:** An individual positioning wrench may need to be made.

### 2b.

The cap can be veneered by pressing or layering. Cement the finished crown onto the tightly screwed abutment, and remove any excess cement.

**Note:** There is a specific Vicarbo Zeramex Screw for each abutment. Please note the technical data for Zeramex screws on pages 48-50.

### Required material

Abutment incl. Vicarbo screw (SB15501/SB15502/SB15515), (RB16501/RB16502/RB16515), (WB17501/WB17502/WB17515), Zerabase X/Zerabase incl. Vicarbo screw (SB15535/SB15536), (RB16535/RB16536/RB16530/RB16531), (WB17535/WB17536/WB17530/WB17531), Customized abutments (SB1551),(RB16551),(WB17551), Prosthetic key (XT38619/XT38623/XT38628)

# Platform switching

To prevent potential crestal bone loss or to increase the soft tissue volume around the implant platform, the excellent prosthetic flexibility of the Zeramex XT system allows platform switching with two options available.



1.



**Zeramex XT SB Abutments**  
SB15501/SB15502/SB15515



**Zeramex XT RB Implants**  
XT16508/XT16510/XT16512/XT16514



**Examples**  
SB 15501  
XT16510

2.



**Zeramex XT RB Abutments**  
RB16501/RB16502/RB16515



**Zeramex XT WB Implants**  
XT17508/XT17510/XT17512



**Examples**  
RB 16501  
XT17510

## Zeramex XT Platform Switching options

1.

It is possible to place a Zeramex XT SB abutment (SB15501/SB15502/SB15515/SB15535/SB15536/SB15551) on any Zeramex XT RB implant (XT16508/XT16510/XT16512/XT16514).

2.

It is possible to place a Zeramex XT RB abutment (RB16501/RB16502/RB16515/RB16535/RB16536/RB16530/RB16531/RB16551) on any Zeramex XT WB implant (XT17508/XT17510/XT17512).

### Caution!

There is no option for platform switching for Zeramex XT WB implants with Zeramex XT SB abutments.



# Screwed prosthetic restoration CAD/CAM

## Zerabase and Zerabase X for customized abutments

### Screwed, all-ceramic restorations

Zeramex allows you to combine 100% metal-free dentures with highly efficient workflows. Zeramex Zerabase and Zerabase X provide you with the basis for your individually shaped abutment for occlusal screwed restorations. Work with your preferred work process and use Exocad or 3Shape software for digital workflows.

### High flexibility

- Design the abutment the way you want it
- Individual shaping facilitates optimum aesthetics
- Residual cement can be removed easily and safely since preparation margins can be shaped ideally
- Design the abutment in a way that achieves ideal crown support and a stable fit
- Suitable for screw-retained and cement-retained restorations



### Work processes

The Zeramex Zerabase Abutment and the smaller adhesive base Zerabase X allow you to work using your preferred work process.

#### Conventional work process

- Creating wax-up for moulded or milled restorations

#### Digital work process (digital design in exocad or 3Shape software)

- Machined abutment → scanning without Scanbody and designing in the software
- Non-machined abutment → scanning in Scanbody and designing in the software

### Production

The cap or crown will be milled in your laboratory, in the milling centre of your choice, or chair-side

### Leading software

The Zeramex Zerabase X Abutments are integrated in the market-leading systems: exocad and 3Shape.

**exocad:** The library will be updated automatically to include the Zeramex Zerabase and Zerabase X Abutments. Exception: Systems from Zirkonzahn and Amann Girrbach require that files be imported manually

**3Shape:** Please download the files from our website and import them into your system.

### Information!

You can find all files on our website: [www.zeramex.com](http://www.zeramex.com).

# Screwed prosthetic restoration CAD/CAM

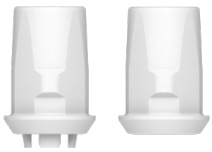

Zerabase  
engaging/non-engaging



Zerabase X  
engaging/non-engaging



Scanbody

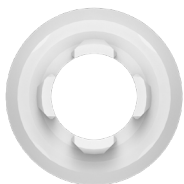

Zerabase and  
Zerabase X for  
crowns

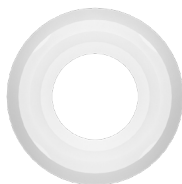

Zerabase and  
Zerabase X for  
bridges and  
bars



Example of Zerabase  
RB16530

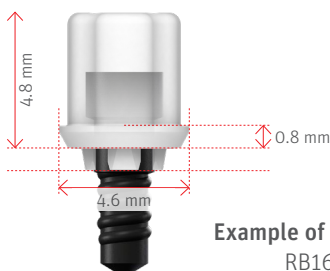

Example of Zerabase X  
RB16535

## Features & Benefits

### Zerabase and Zerabase X Abutment

- Precise, stable Zeramex original connection for high stability
- Retentive element and phase for precise placing of cap or crown
- Adhesion surfaces for optimum retention and adhesion of the restoration

### Zeramex Scanbody

- Ideal geometry for precise digital recording
- Stable polymer for multiple use in the laboratory
- Scanbody tightening torque: **max. 5 Ncm**

**Note:** Please do not grind the Zeramex Scanbodies. There is a possibility, that the system could no longer recognise it.

## The right match for your indication

### Zerabase and Zerabase X for crowns (engaging):

The four interlocks secure the position on the implant.

### Zerabase and Zerabase X for bridges and bars (non-engaging):

No protection against rotation

## Processing information & material

### Processing information

- Final tightening torque of abutment with Vicarbo screw: SB, RB and WB: **25 Ncm** (in lab, use Try-In Screws: **max. 5 Ncm**)
- CTE for ZrO<sub>2</sub> ATZ:  $9 \times 10^{-6}/K$
- Adhesion using commercially-available adhesives

### Material

- Zerabase and Zerabase X Abutments: zirconia dioxide, ATZ
- Zeramex Scanbody: PEEK
- Screw: Vicarbo (carbon-fibre-reinforced high-performance polymer)

# Zeramex Digital Solutions

XT

In addition to the production of customized abutments and monolithic crowns with Zeramex XT implant connections, the Zeramex Digital Solutions: competence centre offers you a service for processing your digital data or for the finishing of semi-finished blank restorations.



**1.** The impression is taken with an intraoral scanner or a classic impression in the patient with a master model that is then scanned.

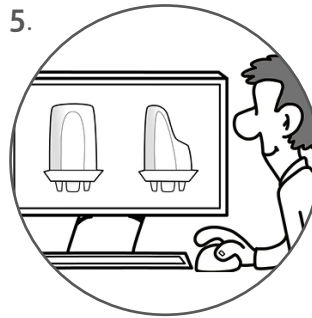

**5.** It is also possible to order a custom crown for Zerabase or other abutments directly from us.

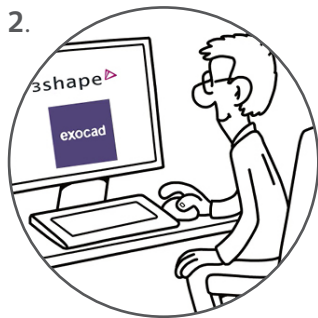

**2.** Model the crown or the customized abutment in your 3Shape or Exocad software to create the required design.

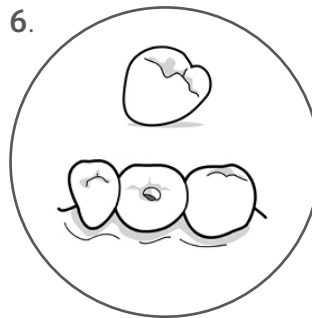

**6.** As required, these can be supplied with and without screw hole.

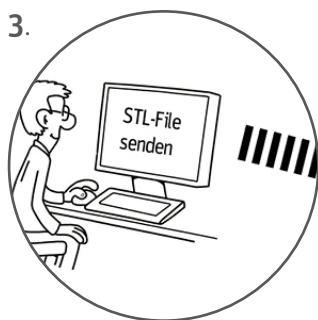

**3.** Send us the digital data conveniently as an STL file and keep an overview of the current status of your data.

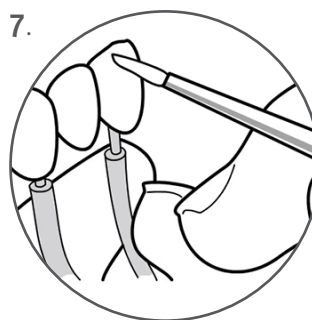

**7.** All of our custom zirconia crowns are also available ready coloured and glazed.

**8.** Within just one week you will receive the precisely fitting prosthetic restoration you require – ready for immediate use. A 3D-printed model can also be produced on request.

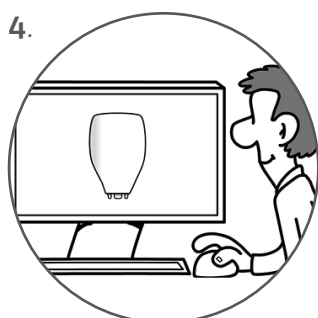

**4.** Zeramex Digital Solutions will produce the complete restoration including the Zeramex implant connection. This can be in the form of an customized abutment or as a one-piece monolith crown without joints and adhesive gap.

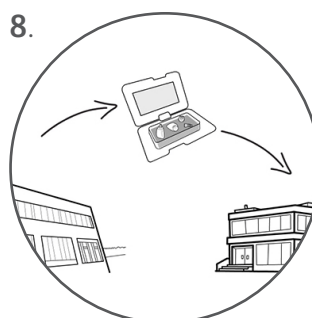

Zeramex Digital Solutions  
00800 0400 1333  
[digitalsolutions@zeramex.com](mailto:digitalsolutions@zeramex.com)  
[www.zeramex.com](http://www.zeramex.com)

> Send data

# Zeramex Digital Solutions

## Offer

Sample images: Differs from original!



Customized ceramic Gingivaformer  
(SB15554/RB16554/WB17554)



Customized Abutment  
(incl. Vicarbo Schraube)  
(SB15551/RB16551/WB17551)



Customized zirconia crown  
for Zerabase or Zerabase X without screw  
hole (unglazed)\*  
(SB15552/RB16552/WB17552)



Customized zirconia crown  
for Zerabase or Zerabase X with screw  
hole (unglazed)\*  
(SB15553/RB16553/WB17553)



Monolithic crown  
With implant connection  
(incl. Vicarbo screw)  
(SB15560/RB16560/WB17560)



Monolithic bridge 3-unit  
(incl. Vicarbo screw)  
(SB15565/RB16565/WB17565)



Monolithic bridge 3-unit  
cutback (incl. Vicarbo screw)  
(SB15566/RB16566/WB17566)



Stain & Glaze  
SB/RB/WB  
(RB16571)



3D model OK/UK  
(without Replica)  
(RB16570)

Material: ZrO<sub>2</sub> TZP-A

CTE: ZrO<sub>2</sub> TZP-A: 10,5

**Important: All products also available as multilayers (see assortment from page 62)**

\*excl. Zerabase / Zerabase X Abutment

Available colours (colour scale VITA)

A1	A2	A3	A3.5	A4	B1	B2	B3	B4	C1	C2	C3	C4	D2	D3	D4
----	----	----	------	----	----	----	----	----	----	----	----	----	----	----	----

Caution! Available for all products except RB16570.

Zeramex Digital Solutions  
00800 0400 1333  
[digitalsolutions@zeramex.com](mailto:digitalsolutions@zeramex.com)  
[www.zeramex.com](http://www.zeramex.com)

> Send data

# Zeramex Docklocs® Abutments

XT

## Do not overtighten

The unique torque for the Vicarbo screw of the Docklocs® Abutments for all platforms is **(SB/RB/WB): max. 15 Ncm.**



## Sequence

Zeramex Docklocs® is a pre-finished connection system to secure removable restorations based on a snap connection.

**Note:** Zeramex Docklocs® Abutments are available in three heights (2 mm/3 mm/4 mm) and fit on all platforms (SB/RB/WB).

1.

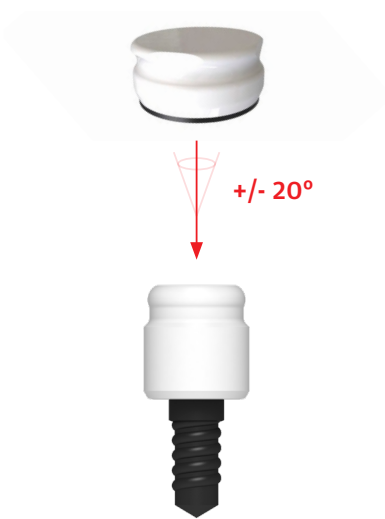

2.

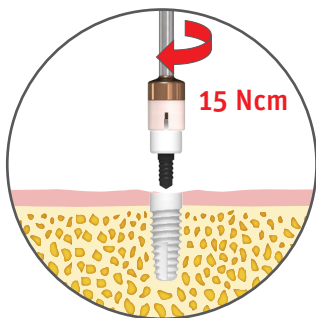

## 1. Divergences

The Zeramex Docklocs® system offers the option of integrating a dental prosthesis for implantation that diverges by up to 20°. This means that deviations between two implants of **up to 40°** can be corrected.

## 2. Insert the Zeramex Docklocs® Abutment

Ensure that the implant shoulder is not covered by hard or soft tissue. Screw the Zeramex Docklocs® Abutment with the Zeramex Docklocs® Insertion Instrument (XT38227) into the implant and tighten by hand. Tighten the abutment with the ratchet, the ratchet adapter and the Zeramex Docklocs® Insertion Instrument to **15 Ncm.**

**Note:** Horizontal alignment of all Zeramex Docklocs® Abutments makes the insertion of the prosthesis easier for the patient.

# Zeramex Docklocs® Abutments

## Technical data

The Zeramex Docklocs® system consists of a Zeramex Docklocs® Abutment, the matching insertion instrument, a Zeramex Docklocs® housing, a Zeramex Docklocs® blockout ring, a Zeramex Docklocs® lab analogue, a Zeramex Docklocs® impression post and three exchangeable Zeramex Docklocs® polyamide retention inserts (PA12) with different colour-coded retention values and pull-off forces.



### Zeramex Docklocs® Abutments (2 mm/3 mm/4 mm)



Zeramex Docklocs® Abutment 2 mm (SB15542)

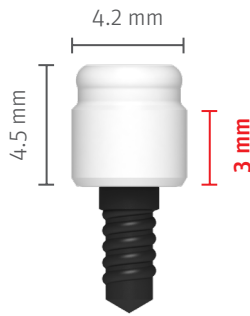

Zeramex Docklocs® Abutment 3 mm (SB15543)

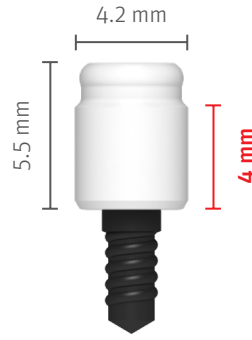

Zeramex Docklocs® Abutment 4 mm (SB15544)

### Zeramex Docklocs® Insertion Instrument

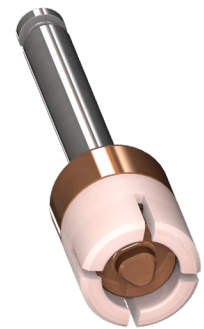

Zeramex Docklocs® Insertion instrument (XT38227)

### Zeramex Docklocs® Retention inserts

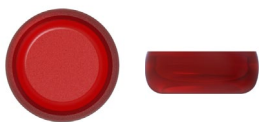

Red: 0.45 kg (Extra-light retention) (XT38205)



Orange: 0.91 kg (Light retention) (XT38206)



Green: 1.81 kg (Strong retention) (XT38207)

**Note:** The Zeramex Docklocs® retention inserts can be exchanged without tension using a conventional assembly and disassembly instrument for retention inserts.

Docklocs® is a registered trademark of MEDEALIS GmbH, DE and our alternative to the LOCATOR® technique.

### Zeramex Docklocs® Zirconia Housing



Zeramex Docklocs® Zirconia Retention Housing (XT38230)

# Technical data for Zeramex XT abutments

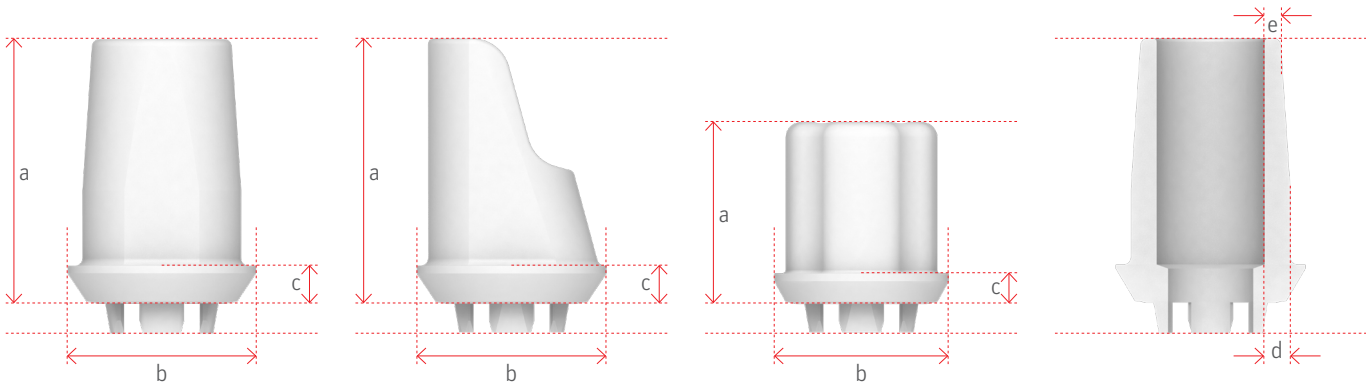

**SB**  
∅ 3.5 mm

		a	b	c	d	e
SB15501	Zeramex XT Abutment SB Straight, 1 mm	7.0	4.6	1.0	0.7	0.6
SB15502	Zeramex XT Abutment SB Straight, 2 mm	8.0	4.6	2.0		
SB15515	Zeramex XT Abutment SB Angular 15°, 1 mm	7.0	4.6	1.0		
SB15535	Zeramex XT Zerabase X SB, Engaging for crown	4.8	4.6	0.8	0.4	-
SB15536	Zeramex XT Zerabase X SB Non-engaging, for bridge	4.8	4.6	0.8		

All dimensions in millimetres

**RB**  
∅ 4.2 mm

		a	b	c	d	e
RB16501	Zeramex XT Abutment RB Straight, 1 mm	7.0	5.0	1.0	0.7	0.6
RB16502	Zeramex XT Abutment RB Straight, 2 mm	8.0	5.0	2.0		
RB16515	Zeramex XT Abutment RB Angular 15°, 1 mm	7.0	5.0	1.0		
RB16535	Zeramex XT Zerabase X RB, Engaging for crown	4.8	4.6	0.8	0.4	-
RB16536	Zeramex XT Zerabase X RB Non-engaging, for bridge	4.8	4.6	0.8		
RB16530	Zeramex XT Zerabase RB, Engaging for Crown	7.0	5.0	1.0	0.7	0.6
RB16531	Zeramex XT Zerabase RB Non-engaging, for Bridge	7.0	5.0	1.0		

All dimensions in millimetres

**WB**  
∅ 5.5 mm

		a	b	c	d	e
WB17501	Zeramex XT Abutment WB Straight, 1 mm	7.0	6.0	1.0	0.7	0.6
WB17502	Zeramex XT Abutment WB Straight, 2 mm	8.0	6.0	2.0		
WB17515	Zeramex XT Abutment WB Angular 15°, 1 mm	7.0	6.0	1.0		
WB17535	Zeramex XT Zerabase X WB, Engaging for crown	4.8	5.6	0.8	0.4	-
WB17536	Zeramex XT Zerabase X WB Non-engaging, for bridge	4.8	5.6	0.8		
WB17530	Zeramex XT Zerabase WB, Engaging for Crown	7.0	6.0	1.0	0.7	0.6
WB17531	Zeramex XT Zerabase WB Non-engaging, for Bridge	7.0	6.0	1.0		

All dimensions in millimetres



# Grinding Standard Abutments

## Do not overtighten

The unique torque for the Vicarbo screw for all platforms (SB/RB/WB) is: **25 Ncm.**



## Example of abutment

Zeramex XT Abutment RB Straight, 1 mm  
RB16501

## Material

ZrO<sub>2</sub> ATZ-HIP

Composition:

- ZrO<sub>2</sub>: 76%
- Al<sub>2</sub>O<sub>3</sub>: 20%
- Y<sub>2</sub>O<sub>3</sub>: 4%

Flexural strength: >1'700 MPa (average  
2'000 MPa)

CTE for ZrO<sub>2</sub> ATZ: 9 × 10<sup>-6</sup>/K

## Procedure

- Conical part (**4.0 mm**) may be shortened.
- Only process under sufficient, continuous water cooling with slight pressure.
- Use high speed (**water-cooled turbine**) and fine grain size (red-ring diamond, smaller than 50 µm).

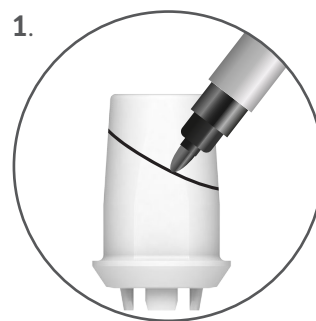

1. Marking (record) of the "Preparation process"

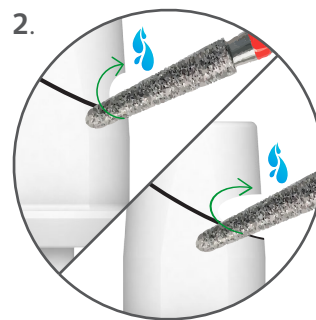

2. Adequate procedure with handpiece: Lightly encircle the preparation position, then expand it in a vertical, V-shaped movement until it is cut through.

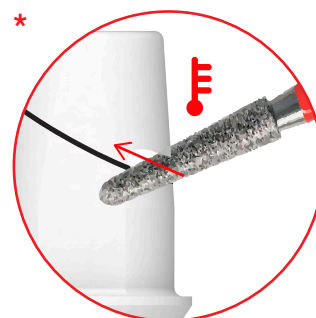

### \* Caution!

Do not cut through zirconia dioxide that is the same thickness of the instruments or grinding tool.

**Risk of overheating!**

# Technical data for Zeramex XT screws

XT

Important distinguishing feature of Zeramex XT screws:

- The Try-In Screw and Vicarbo Screw have no grooves on the screw head and are shorter than the Provisional Screw
- The screw head diameter for the Vicarbo Screw & Try-In Screw is 2.8 mm
- All screws are suitable for Small (SB), Regular (RB) and Wide Base (WB).

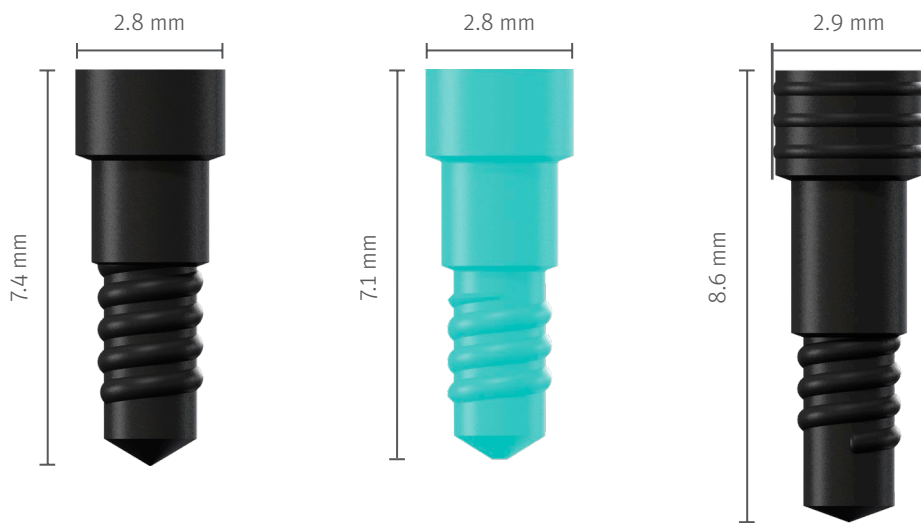

## Vicarbo Screw

RB16550

### Matches:

SB/RB/WB Abutment

### Distinguishing feature:

Length: 7.4 mm  
No grooves on screw head  
Black

### Tightening torque:

**25 Ncm**

### Material:

Vicarbo

### Caution:

This screw is intended for the final treatment and may only be used once! It can be tried on with a max. 15 Ncm torque.

## Try-In Screw

RB36554

### Matches:

SB/RB/WB Abutment

### Distinguishing feature:

Length: 7.1 mm  
No grooves on screw head  
Green

### Tightening torque:

**5 Ncm**

### Material:

PEEK

### Caution:

This screw may only be used in the laboratory and not for the definitive fit!

## Provisional Screw

RB36550

### Matches:

SB/RB/WB provisional

### Distinguishing feature:

Length: 8.6mm  
Ring on screw head  
Black

### Tightening torque:

**15 Ncm**

### Material:

Vicarbo

### Caution:

This screw may only be used for the temporary restoration!

# Technical data for Zeramex XT screws

**Vicarbo Screw**  
(RB16550)  
Tightening torque:  
**25 Ncm**



**Try-In Screw**  
(RB36554)  
Tightening torque:  
**5 Ncm**



**Provisional Screw**  
(RB36550)  
Tightening torque:  
**15 Ncm**



**SB**  
ø 3.5 mm

**RB**  
ø 4.2 mm

**WB**  
ø 5.5 mm

**SB**  
ø 3.5 mm

**RB**  
ø 4.2 mm

**WB**  
ø 5.5 mm



**SB straight, 1 mm**  
(SB15501)



**RB straight, 1 mm**  
(RB16501)



**WB straight, 1 mm**  
(WB17501)



**SB Provisional**  
(SB35530)



**RB Provisional**  
(RB36530)



**WB Provisional**  
(WB37530)



**SB straight, 2 mm**  
(SB15502)



**RB straight, 2 mm**  
(RB16502)



**WB straight, 2 mm**  
(WB17502)



**SB angular, 1 mm**  
15° (SB15515)



**RB angular, 1 mm**  
15° (RB16515)



**WB angular, 1 mm**  
15° (WB17515)



**SB Zerabase X**  
Crown (SB15535)



**RB Zerabase X**  
Crown (RB16535)



**WB Zerabase X**  
Crown (WB17535)



**SB Zerabase X**  
Bridge (SB15536)



**RB Zerabase X**  
Bridge (RB16536)



**WB Zerabase X**  
Bridge (WB17536)



**RB Zerabase**  
Crown (RB16530)



**WB Zerabase**  
Crown (WB17530)



**RB Zerabase**  
Bridge (RB16531)



**WB Zerabase**  
Bridge (WB17531)



**SB custom. Abutment**  
(SB15551\*)



**RB custom. Abutment**  
(RB16551\*)



**WB custom. Abutment**  
(WB17551\*)

\*Sample images: Differs from original!

**SB**  
ø 3.5 mm

**RB**  
ø 4.2 mm

**WB**  
ø 5.5 mm



**SB Scanbody**  
(SB35514)



**RB Scanbody**  
(RB36514)



**WB Scanbody**  
(WB37514)

# The metal-free innovation: Vicarbo screw

Our objective was to offer a 100% metal-free solution in which not only the implant but also the screw are metal-free. We therefore decided to use the high-performance material Vicarbo. Vicarbo is a carbon-fibre reinforced PEEK plastic, in which the carbon fibres are aligned with the longitudinal axis of the material. In this way, we can achieve enormous strength. Thanks to the production process developed by Zeramex, the carbon fibres are not damaged during production and they retain their full function. This screw is unique in dental implantology.

This material has already proved its worth in other medical applications (e.g. orthopaedics) and is considered to be the material of the future. Aerospace engineers also use carbon fibre reinforced components because of their enormous strength and low weight.



## Technical specifications

- Flexural modulus: >130 GPa
- Flexural strength: >900 MPa

## Sterilisation method

- Steam sterilisation at 132 °C / 270 °F or 134 °C / 274 °F /  
Time: 18 minutes

## Do I have to keep the specified tightening torques?

The specified tightening torque must be used to compensate the reduced tension through the tight fit and to ensure a reliable, permanent bond.

## Why does the Vicarbo screw have a conical shoulder?

The conical shoulder of the screw was designed so that the fit with the abutment is as tight as possible without generating lateral forces that could damage the abutment later.

## What material is the Vicarbo screw made from? Why is it black?

The screw is made of PEEK plastic reinforced with longitudinally aligned carbon fibres. The carbon fibres are responsible for the Vicarbo screw's colour.







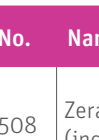

# Zeramex XT Range

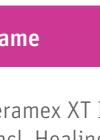

## Zeramex XT Implants

SB Ø3.5 mm	Art. No.	Name	Dimension	Material
	XT15508	Zeramex XT Implant Ø3.5×8 mm SB (incl. Healing Cap)	Length: 8 mm	ZrO <sub>2</sub> -ATZ-HIP
	XT15510	Zeramex XT Implant Ø3.5×10 mm SB (incl. Healing Cap)	Length: 10 mm	
	XT15512	Zeramex XT Implant Ø3.5×12 mm SB (incl. Healing Cap)	Length: 12 mm	

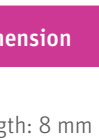
RB Ø4.2 mm	Art. No.	Name	Dimension	Material
	XT16508	Zeramex XT Implant Ø4.2×8 mm RB (incl. Healing Cap)	Length: 8 mm	ZrO <sub>2</sub> -ATZ-HIP
	XT16510	Zeramex XT Implant Ø4.2×10 mm RB (incl. Healing Cap)	Length: 10 mm	
	XT16512	Zeramex XT Implant Ø4.2×12 mm RB (incl. Healing Cap)	Length: 12 mm	
	XT16514	Zeramex XT Implant Ø4.2×14 mm RB (incl. Healing Cap)	Length: 14 mm	

WB Ø5.5 mm	Art. No.	Name	Dimension	Material
	XT17508	Zeramex XT Implant Ø5.5×8 mm WB (incl. Healing Cap)	Length: 8 mm	ZrO <sub>2</sub> -ATZ-HIP
	XT17510	Zeramex XT Implant Ø5.5×10 mm WB (incl. Healing Cap)	Length: 10 mm	
	XT17512	Zeramex XT Implant Ø5.5×12 mm WB (incl. Healing Cap)	Length: 12 mm	

## Zeramex XT Abutments

SB Platform	Art. No.	Name	Dimension	Material
	SB15501	Zeramex XT Abutment SB Straight, 1 mm (incl. screw)	AH: 7 mm CH: 1 mm Ø: 4.6 mm	ZrO <sub>2</sub> -ATZ-HIP Vicarbo
	SB15502	Zeramex XT Abutment SB Straight, 2 mm (incl. screw)	AH: 8 mm CH: 2 mm Ø: 4.6 mm	
	SB15515	Zeramex XT Abutment SB Angular 15°, 1 mm (incl. screw)	AH: 7 mm CH: 1 mm Ø: 4.6 mm	

SB CADCAM	Art. No.	Name	Dimension	Material
	SB15535	Zeramex XT Zerabase X SB, Engaging for crowns (incl. screw)	AH: 4.8 mm CH: 0.8 mm Ø: 4.6 mm	ZrO <sub>2</sub> -ATZ-HIP Vicarbo
	SB15536	Zeramex XT Zerabase X SB Non-engaging for bars & bridges (incl. screw)	AH: 4.8 mm CH: 0.8 mm Ø: 4.6 mm	

Zerabase Abutments are integrated into the systems of 3Shape and exocad.

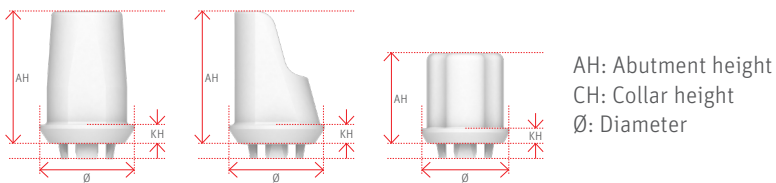

SB/RB/WB Vicarbo Screw	Art. No.	Name	Dimension	Material
	RB16550	Zeramex XT (SB/RB/WB) Vicarbo screw, Straight/Angular/CADCAM/Zerabase X/Customized abutments	Length: 7.4 mm	Vicarbo



## Zeramex XT Abutments

RB Platform	Art. No.	Name	Dimension	Material
	RB16501	Zeramex XT Abutment RB Straight, 1 mm (incl. screw)	AH: 7 mm CH: 1 mm Ø: 5 mm	ZrO <sub>2</sub> -ATZ-HIP Vicarbo
	RB16502	Zeramex XT Abutment RB Straight, 2 mm (incl. screw)	AH: 8 mm CH: 2 mm Ø: 5 mm	
	RB16515	Zeramex XT Abutment RB Angular 15°, 1 mm (incl. screw)	AH: 7 mm CH: 1 mm Ø: 5 mm	

RB CADCAM	Art. No.	Name	Dimension	Material
	RB16535	Zeramex XT Zerabase X RB, Engaging for crowns (incl. screw)	AH: 4.8 mm CH: 0.8 mm Ø: 4.6 mm	ZrO <sub>2</sub> -ATZ-HIP Vicarbo
	RB16536	Zeramex XT Zerabase X RB Non-engaging for bars & bridges (incl. screw)	AH: 4.8 mm CH: 0.8 mm Ø: 4.6 mm	
	RB16530	Zeramex XT Zerabase RB, Engaging for crowns (incl. screw)	AH: 7 mm CH: 1 mm Ø: 5 mm	
	RB16531	Zeramex XT Zerabase RB Non-engaging for bars & bridges (incl. screw)	AH: 7 mm CH: 1 mm Ø: 5 mm	

Zerabase X Abutments are integrated into the systems of 3Shape and exocad.

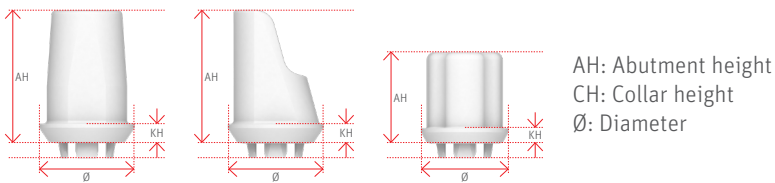







SB/RB/WB Vicarbo Screw	Art. No.	Name	Dimension	Material
	RB16550	Zeramex XT (SB/RB/WB) Vicarbo screw, Straight/Angular/CADCAM/Zerabase X/Customized abutments	Length: 7.4 mm	Vicarbo

# Range

XT

## Zeramex XT Abutments

WB Platform	Art. No.	Name	Dimension	Material
	WB17501	Zeramex XT Abutment WB Straight, 1 mm (incl. screw)	AH: 7 mm CH: 1 mm Ø: 6 mm	ZrO <sub>2</sub> -ATZ-HIP Vicarbo
	WB17502	Zeramex XT Abutment WB Straight, 2 mm (incl. screw)	AH: 8 mm CH: 2 mm Ø: 6 mm	
	WB17515	Zeramex XT Abutment WB Angular 15°, 1 mm (incl. screw)	AH: 7 mm CH: 1 mm Ø: 6 mm	



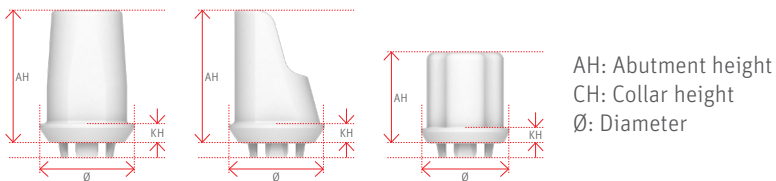

WB CADCAM	Art. No.	Name	Dimension	Material
	WB17535	Zeramex XT Zerabase X WB Engaging for crowns (incl. screw)	AH: 4.8 mm CH: 0.8 mm Ø: 5.6 mm	ZrO <sub>2</sub> -ATZ-HIP Vicarbo
	WB17536	Zeramex XT Zerabase X WB Non-engaging for bars & bridges (incl. screw)	AH: 4.8 mm CH: 0.8 mm Ø: 5.6 mm	
	WB17530	Zeramex XT Zerabase WB Engaging for crowns (incl. screw)	AH: 7 mm CH: 1 mm Ø: 6 mm	
	WB17531	Zeramex XT Zerabase WB Non-engaging for bars & bridges (incl. screw)	AH: 7 mm CH: 1 mm Ø: 6 mm	



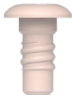

Zerabase Abutments are integrated into the systems of 3Shape and exocad.





SB/RB/WB Vicarbo Screw	Art. No.	Name	Dimension	Material
	RB16550	Zeramex XT (SB/RB/WB) Vicarbo screw, Straight/Angular/CADCAM/Zerabase X/Customized abutments	Length: 7.4 mm	Vicarbo

## Zeramex Prosthetics

SB soft tissue management	Art. No.	Name	Dimension	Material
	SB35500	Zeramex XT Healing Cap SB	Height: 0.6 mm	PEEK
	SB35503	Zeramex XT Gingivaformer SB, 3 mm	Height: 3 mm Ø: 4 mm	
	SB35504	Zeramex XT Gingivaformer SB, 4 mm	Height: 4 mm Ø: 4 mm	
	SB35530	Zeramex XT Provisional SB (incl. Provisional Screw)	AH: 7 mm CH: 1 mm Ø: 4 mm	PEEK Vicarbo





SB Impression Taking	Art. No.	Name	Dimension	Material
	SB35510	Zeramex XT Transfer Open Tray SB	High sleeve: 11 mm / height incl. screw: 20 mm	Aluminium PEEK-CW30
	SB35512	Zeramex XT Transfer Closed Tray SB	High sleeve: 7 mm / height incl. screw: 14 mm	
	SB35513	Zeramex XT Transfer Closed Tray, long SB	High sleeve: 11 mm / height incl. screw: 18 mm	
	SB35514	Zeramex XT Scanbody SB (incl. Provisional Screw)	Height: 10 mm	PEEK Vicarbo
	SB35522	Zeramex XT Digital Implant Replica SB	Length: 10 mm	Aluminium



RB soft tissue management	Art. No.	Name	Dimension	Material
	RB36500	Zeramex XT Healing Cap RB	Height: 0.6 mm	PEEK
	RB36503	Zeramex XT Gingivaformer RB, 3 mm	Height: 3 mm Ø: 5 mm	
	RB36504	Zeramex XT Gingivaformer RB, 4 mm	Height: 4 mm Ø: 5 mm	

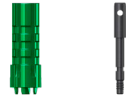
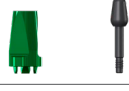

# Range

XT

	RB36530	Zeramex XT Provisional RB (incl. Provisional Screw)	AH: 7 mm CH: 1 mm Ø: 5 mm	PEEK Vicarbo
---	---------	--	---------------------------------	-----------------

RB Impression Taking	Art. No.	Name	Dimension	Material
	RB36510	Zeramex XT Transfer Open Tray RB	High sleeve: 11 mm / height incl. screw: 20 mm	Aluminium PEEK-CW30
	RB36512	Zeramex XT Transfer Closed Tray RB	High sleeve: 7 mm / height incl. screw: 14 mm	
	RB36513	Zeramex XT Transfer Closed Tray, long RB	High sleeve: 11 mm / height incl. screw: 18 mm	
	RB36514	Zeramex XT Scanbody RB (incl. Provisional Screw)	Height: 10 mm	PEEK Vicarbo
	RB36522	Zeramex XT Digital Implant Replica RB	Length: 10 mm	Aluminium

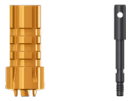
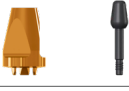

WB soft tissue management	Art. No.	Name	Dimension	Material
	WB37500	Zeramex XT Healing Cap WB	Height: 0.6 mm	PEEK
	WB37503	Zeramex XT Gingivaformer WB, 3 mm	Height: 3 mm Ø: 6 mm	
	WB37504	Zeramex XT Gingivaformer WB, 4 mm	Height: 4 mm Ø: 6 mm	
	WB37530	Zeramex XT Provisional WB (incl. Provisional Screw)	AH: 7 mm CH: 1 mm Ø: 6 mm	PEEK Vicarbo







WB Impression Taking	Art. No.	Name	Dimension	Material
	WB37510	Zeramex XT Transfer Open Tray WB	High sleeve: 11 mm / height incl. screw: 20 mm	Aluminium PEEK-CW30
	WB37512	Zeramex XT Transfer Closed Tray WB	High sleeve: 7 mm / height incl. screw: 14 mm	
	WB37513	Zeramex XT Transfer Closed Tray, long WB	High sleeve: 11 mm / height incl. screw: 18 mm	

# Range

XT







	WB37514	Zeramex XT Scanbody WB (incl. screw)	Height: 10 mm	PEEK PEEK-CW30
	WB37522	Zeramex XT Digital Implant Replica WB	Length: 10 mm	Aluminium

SB/RB/WB Auxiliary Parts	Art. No.	Name	Dimension	Material
	RB36521	Zeramex XT Digital Implant Replica Placer (SB/RB/WB)	Length: 14 mm	PEEK-CW30
	RB36550	Zeramex XT Provisional Screw (SB/RB/WB)	Length: 8.6 mm	Vicarbo
	RB36554	Zeramex XT Try-In Screw (SB/RB/WB)	Length: 7.1 mm	PEEK

Zeramex Docklocs®	Art. No.	Name	Material
	SB15542	Zeramex Docklocs® Abutment, 2 mm	ZrO <sub>2</sub> -ATZ-HIP Vicarbo
	SB15543	Zeramex Docklocs® Abutment, 3 mm	
	SB15544	Zeramex Docklocs® Abutment, 4 mm	
	XT38227	Zeramex Docklocs® Insertion Instrument	Stainless steel PEEK
	XT38253	Docklocs® Laboratory Set, up to 40° divergence compensation: 2 pcs zirconia oxide retention housing (Ø5.8 mm, height 2.5 mm) with black processing insert (height 1.9 mm), 2 pcs block-out ring, 2 pcs replacement male, green, 2 pcs replacement male, orange, 2 pcs replacement male, red	Santroprene® TPE Polyamide Housing ZrO <sub>2</sub> HD-PE Purell
	XT38251	Docklocs® Laboratory Set, up to 40° divergence compensation: 2 pcs titanium retention housing (Ø5.5 mm, height 2.5 mm) with black processing insert (height 1.9 mm), 2 pcs block-out ring, 2 pcs replacement male, green, 2 pcs replacement male, orange, 2 pcs replacement male, red	Santroprene® TPE Polyamide Titanium housing HD-PE Purell









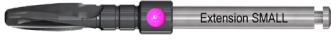

# Range

	XT38205	Docklocs® Replacement Male, red Extra-light retention, 10°–20° 8 pcs	Polyamide
	XT38206	Docklocs® Replacement Male, orange Light retention, 10°–20° 8 pcs	
	XT38207	Docklocs® Replacement Male, green Strong retention, 10°–20° 8 pcs	
	XT38209	Docklocs® Block-out Ring 20 pcs	Santoprene® TPE
	XT38230	Zirconia oxide retention housing with processing insert 2 pcs	Housing ZrO <sub>2</sub> HD-PE Purell
	XT38210	Titanium retention housing with processing insert 4 pcs	Titanium housing G5 HD-PE Purell
	XT38214	Docklocs® lab analogue straight (Ø4 mm) 4 pcs	Grade 5 titanium
	XT38215	Docklocs® impression coping with black processing insert 4 pcs	Titanium housing G5 HD-PE Purell

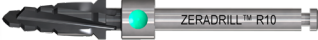
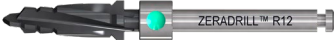
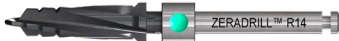
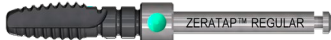
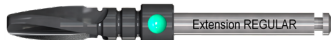
SB/RB/WB Tools	Art. No.	Name	Material
	P35601	Zeramex Rosedrill Ø2 mm	Stainless steel
	T35602	Zeradriill Pilot Ø2.3 mm	
	XT35630	Zeramex Profile Drill SB	Stainless steel with carbon coating
	T35608	Zeradriill S8 (Small 8 mm)	
	T35610	Zeradriill S10 (Small 10 mm)	
	T35612	Zeradriill S12 (Small 12 mm)	

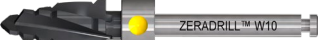
# Range

















	T35614	Zeradrill S14 (Small 14 mm)	Stainless steel with carbon coating
	T35620	Zeratap Small Ø3.5 mm	
	T35622	Zeradrill Extension Small	
	T36608	Zeradrill R8 (Regular 8 mm)	
	T36610	Zeradrill R10 (Regular 10 mm)	
	T36612	Zeradrill R12 (Regular 12 mm)	
	T36614	Zeradrill R14 (Regular 14 mm)	
	T36620	Zeratap Regular Ø4.2 mm	
	T36622	Zeradrill Extension Regular	
	T37608	Zeradrill W8 (Wide 8 mm)	
	T37610	Zeradrill W10 (Wide 10 mm)	
	T37612	Zeradrill W12 (Wide 12 mm)	
	T37620	Zeratap Wide Ø5.5 mm	
	T37622	Zeradrill Extension Wide	
	C7650*	Drill extension	

\*Art. KI589B for Switzerland











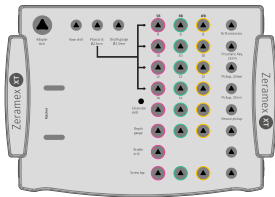



# Range

	T38650	Zeramex T depth gauge, 4 pcs	Stainless steel
	XT38619	Zeramex Prosthetic Key, 19 mm	
	XT38623	Zeramex Prosthetic Key, 23 mm	
	XT38628	Zeramex Prosthetic Key, 28 mm	
	XT36620	Zeramex Pick-up, 20 mm SB/RB/WB	
	XT36625	Zeramex Pick-up, 25 mm SB/RB/WB	
	XT36622	Zeramex Rescue Pick-up SB/RB/WB	
	P48932	Zeramex P Ratchet Adapter Unit Short	
	P48935	Zeramex P Surgical Ratchet without Adapter	
	XT35651	Zeramex XT Drill Stop, for Small Drill	
	XT36651	Zeramex XT Drill Stop, for Regular Drill	
	XT37651	Zeramex XT Drill Stop, for Wide Drill	
	XT48860	Zeramex XT Prosthetics Kit	-
	XT48865	Zeramex XT Prosthetics Kit incl. Ratchet	















# Range



	XT48850	Zeramex XT Surgery Tray	-
	XT48854	Zeramex XT Surgery Tray, fully equipped, incl. Ratchet	

Zeramex Digital Solutions*	Art. No.	Name	Material
	SB15551	Customized Abutment SB (incl. Vicarbo screw)	ZrO <sub>2</sub> -TZP Vicarbo
	SB15552	Customized zirconia crown for Zerabase <u>without</u> screw hole (unglazed & excl. Zerabase Abutment) SB	ZrO <sub>2</sub> -TZP
	SB15553	Customized zirconia crown for Zerabase <u>with</u> screw hole (unglazed & excl. Zerabase Abutment) SB	
	SB15554	Customized zirconia Gingivaformer SB (incl. Vicarbo screw)	ZrO <sub>2</sub> -TZP Vicarbo
	SB15560	Monolithic crown SB (incl. Vicarbo screw)	ZrO <sub>2</sub> -TZP Vicarbo
	SB15561	2 monolithic crowns splinted SB (incl. Vicarbo screw)	
	SB15565	Monolithic bridge 3-unit SB (incl. Vicarbo screw)	
	SB15566	Monolithic bridge 3-unit SB (incl. Vicarbo screw) cutback	
	SB15590	Package customized: Zirconia Gingivaformer & Abutment SB (incl. Vicarbo screw)	
	SB15591	Package Monolithic: Zirconia Gingivaformer & crown SB (incl. Vicarbo screw)	
	RB16551	Customized Abutment RB (incl. Vicarbo screw)	









# Range

	RB16552	Customized zirconia crown for Zerabase <u>without</u> screw hole (unglazed & excl. Zerabase Abutment) RB	ZrO <sub>2</sub> -TZP
	RB16553	Customized zirconia crown for Zerabase <u>with</u> screw hole (unglazed & excl. Zerabase Abutment) RB	
	RB16554	Customized zirconia Gingivaformer RB (incl. Vicarbo screw)	ZrO <sub>2</sub> -TZP Vicarbo
	RB16560	Monolithic crown RB (incl. Vicarbo screw)	ZrO <sub>2</sub> -TZP Vicarbo
	RB16561	2 monolithic crowns splinted RB (incl. Vicarbo screw)	
	RB16565	Monolithic bridge 3-unit RB (incl. Vicarbo screw)	
	RB16566	Monolithic bridge 3-unit RB (incl. Vicarbo screw) cutback	
	RB16590	Package customized: Zirconia Gingivaformer & Abutment RB (incl. Vicarbo screw)	
	RB16591	Package Monolithic: Zirconia Gingivaformer & crown RB (incl. Vicarbo screw)	
	WB17551	Customized Abutment WB (incl. Vicarbo screw)	
	WB17552	Customized zirconia crown for Zerabase <u>without</u> screw hole (unglazed & excl. Zerabase Abutment) WB	ZrO <sub>2</sub> -TZP
	WB17553	Customized zirconia crown for Zerabase <u>with</u> screw hole (unglazed & excl. Zerabase Abutment) WB	
	WB17554	Customized zirconia Gingivaformer WB (incl. Vicarbo screw)	ZrO <sub>2</sub> -TZP Vicarbo
	WB17560	Monolithic crown WB (incl. Vicarbo screw)	ZrO <sub>2</sub> -TZP Vicarbo
	WB17561	2 monolithic crowns splinted WB (incl. Vicarbo screw)	



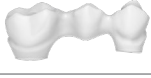

# Range



	WB17565	Monolithic bridge 3-unit WB (incl. Vicarbo screw)	ZrO <sub>2</sub> -TZP Vicarbo
	WB17566	Monolithic bridge 3-unit WB (incl. Vicarbo screw) cutback	
	WB17590	Package customized: Zirconia Gingivaformer & Abutment WB (incl. Vicarbo screw)	
	WB17591	Package Monolithic: Zirconia Gingivaformer & crown WB (incl. Vicarbo screw)	







Zeramex Digital Solutions Multilayer*	Art. No.	Name	Material
	SB15751	Customized Abutment SB, ML (incl. Vicarbo screw)	ZrO <sub>2</sub> -TZP Vicarbo
	SB15752	Customized zirconia crown for Zerabase <u>without</u> screw hole, ML (unglazed & excl. Zerabase Abutment) SB	ZrO <sub>2</sub> -TZP
	SB15753	Customized zirconia crown for Zerabase <u>with</u> screw hole, ML (unglazed & excl. Zerabase Abutment) SB	
	SB15754	Customized zirconia Gingivaformer SB, ML (incl. Vicarbo screw)	ZrO <sub>2</sub> -TZP Vicarbo
	SB15760	Monolithic crown SB, ML (incl. Vicarbo screw)	ZrO <sub>2</sub> -TZP Vicarbo
	SB15761	2 monolithic crowns splinted SB, ML (incl. Vicarbo screw)	
	SB15765	Monolithic bridge 3-unit SB, ML (incl. Vicarbo screw)	
	SB15766	Monolithic bridge 3-unit SB, ML (incl. Vicarbo screw) cutback	
	SB15790	Package customized: Zirconia Gingivaformer & Abutment SB, ML (incl. Vicarbo screw)	



# Range

	SB15791	Package Monolithic: Zirconia Gingivaformer & crown SB, ML (incl. Vicarbo screw)	ZrO <sub>2</sub> -TZP Vicarbo
	RB16751	Customized Abutment RB, ML (incl. Vicarbo screw)	
	RB16752	Customized zirconia crown for Zerabase <u>without</u> screw hole, ML (unglazed & excl. Zerabase Abutment) RB	ZrO <sub>2</sub> -TZP
	RB16753	Customized zirconia crown for Zerabase <u>with</u> screw hole, ML (unglazed & excl. Zerabase Abutment) RB	
	RB16754	Customized zirconia Gingivaformer RB, ML (incl. Vicarbo screw)	ZrO <sub>2</sub> -TZP Vicarbo
	RB16760	Monolithic crown RB, ML (incl. Vicarbo screw)	ZrO <sub>2</sub> -TZP Vicarbo
	RB16761	2 monolithic crowns splinted RB, ML (incl. Vicarbo screw)	
	RB16765	Monolithic bridge 3-unit RB, ML (incl. Vicarbo screw)	
	RB16766	Monolithic bridge 3-unit RB, ML (incl. Vicarbo screw) cutback	
	RB16790	Package customized: Zirconia Gingivaformer & Abutment RB, ML (incl. Vicarbo screw)	
	RB16791	Package Monolithic: Zirconia Gingivaformer & crown RB, ML (incl. Vicarbo screw)	
	WB17751	Customized Abutment WB, ML (incl. Vicarbo screw)	ZrO <sub>2</sub> -TZP
	WB17752	Customized zirconia crown for Zerabase <u>without</u> screw hole, ML (unglazed & excl. Zerabase Abutment) WB	
	WB17753	Customized zirconia crown for Zerabase <u>with</u> screw hole, ML (unglazed & excl. Zerabase Abutment) WB	
	WB17754	Customized zirconia Gingivaformer WB, ML (incl. Vicarbo screw)	ZrO <sub>2</sub> -TZP Vicarbo

# Range



	WB17760	Monolithic crown WB, ML (incl. Vicarbo screw)	ZrO <sub>2</sub> -TZP Vicarbo
	WB17761	2 monolithic crowns splinted WB, ML (incl. Vicarbo screw)	
	WB17765	Monolithic bridge 3-unit WB, ML (incl. Vicarbo screw)	
	WB17766	Monolithic bridge 3-unit WB, ML (incl. Vicarbo screw) cutback	
	WB17790	Package customized: Zirconia Gingivaformer & Abutment WB, ML (incl. Vicarbo screw)	
	WB17791	Package Monolithic: Zirconia Gingivaformer & crown WB, ML (incl. Vicarbo screw)	

Zeramex Digital Solutions Services*	Art. No.	Name	Material
	RB16570	3D model OK/UK (without Replica) SB/RB/WB	
	RB16571	Stain & Glaze SB/RB/WB	
-	RB16580	Zeramex SB, RB & WB Individuelle Designentwicklung	-
-	RB16581	Zeramex Scan (alle Produkte)	
-	RB16582	Zeramex SB, RB & WB Virtuelles Modelldesign aufgrund Intraoralscandaten	

**\*Sample images/differs from original!**

Docklocs® is a registered trademark of MEDEALIS GmbH, DE.  
Santoprene® is a registered trademark of Exxon Mobil Corporation, USA.

# General Information

## Guarantee

CeramTec Switzerland LLC offers a lifelong guarantee for implants, and a 10-year guarantee for abutments and Vicarbo screws. The Zeramex warranty conditions apply.

## Certification

CE / CE<sub>0483</sub> / CE<sub>0500</sub> (see p. 68)

## Delivery and packaging

Delivery is in accordance with the general terms and conditions (T&Cs) of CeramTec Switzerland LLC. Intact sterile packaging protects the implant from external influences and ensures sterile storage up to the printed expiration date. Zeramex XT implants and components must be stored dry in their original packaging at room temperature and protected from sunlight. Only open the packaging shortly before surgery. We recommend comprehensive clinical, radiological and statistical documentation. The inside labels (patient label) must allow traceability of the implants.

## Exclusion of liability

Zeramex XT implants are part of an overall system and may be used only with the components designed

for this system. CeramTec Switzerland LLC will not be held liable for any damage arising from improper use, or from using non-original components. The general terms and conditions of CeramTec Switzerland LLC also apply.

## Training

For information on courses and further education for the Zeramex XT System, please contact us at [www.zeramex.com](http://www.zeramex.com).

## Material properties

All implants and abutments are made from hot-densified zirconia oxide ATZ-HIP® (HIP = Hot Isostatic Postcompaction). For reasons of quality and strength, the implants and abutments are strictly machined into their final shape from solid, hard blanks using diamond-coated tools. The workpiece does not need finishing. This allows for highly precise and reproducible production of implants and abutments with the necessary precise fit.

## Zerafil implant surface

- Microstructured
- Blasted and etched
- Hydrophilic

## ZrO<sub>2</sub> ATZ-HIP

Zirconia dioxide, ATZ (alumina-toughened zirconia) (radiopaque)

### Composition:

ZrO<sub>2</sub> 76%, Al<sub>2</sub>O<sub>3</sub> 20%, Y<sub>2</sub>O<sub>3</sub> 4%

Flexural strength: >1700 MPa (on average 2000 MPa)

CTE: 9x10<sup>-6</sup>/K

## ZrO<sub>2</sub> TZP-A

Zirconia dioxide, TZP (tetragonal zirconia polycrystal) (radiopaque)

### Composition:

ZrO<sub>2</sub> 95%, Al<sub>2</sub>O<sub>3</sub> 5%, Y<sub>2</sub>O<sub>3</sub> 0.25%

Flexural strength: 1,200 MPa.

CTE: 10,5

## PEEK CLASSIX

Polyether ether ketone USP Class VI (not radiopaque)

## Aluminium

Aluminium (not radiopaque)

## PEEK CLASSIX CW30 LSG

Short carbon fibres (CF) in a PEEK CLASSIX LSG matrix (not radiopaque)

### Composition:

CF 30%, PEEK Classix LSG 70%

Flexural strength: >130 MPa

## Vicarbo

Unidirectional carbon fibres (CF) in a PEEK matrix (not radiopaque)

### Composition:

CF 60%, PEEK 40%

Flexural strength: >900 MPa.



# General Information



	CE Mark for MDR (2017/745) Class I devices		CE Mark for legacy devices Class IIa / IIb
	CE Mark for MDR (2017/745) Class IIa / IIb devices		Caution
	Article number		Expiry date
	Batch code		Observe the instructions for use
	Do not reuse		Date of manufacture
	Non-sterile		Manufacturer
	Sterilisation by steam or dry heat		Do not use if the packaging is damaged
	Keep away from direct sunlight		
	Keep dry		Medical device
	Unique Device Identifier		EU authorised representative
	Sterile barrier system		Double packaging with single internal sterile barrier
	Do not resterilise		Gamma sterilisation
Rx only	CAUTION: US federal law restricts the sale of this product to a physician or on his or her order.		
	Implant Small ø3.5 mm SB		Implant Regular ø4.2 mm RB
	Implant Wide ø5.5 mm WB		

# Contact

## Europe

### **Order hotline for Germany, Switzerland and Austria**

Phone: 00800 93 55 66 37

Fax: 00800 93 55 63 77

Email: [order@zeramex.com](mailto:order@zeramex.com)

### **Zeramex Digital Solutions**

Phone: 00800 04 00 13 33

Email: [digitalsolutions@zeramex.com](mailto:digitalsolutions@zeramex.com)

## Switzerland

CeramTec Switzerland LLC

Bodenackerstrasse 5

8957 Spreitenbach/Switzerland

Phone: 0041 44 388 36 36

Fax: 0041 44 388 36 39

Email: [info@zeramex.com](mailto:info@zeramex.com)

Web: [www.zeramex.com](http://www.zeramex.com)

## Germany (EU sales)

CeramTec Dentalvertriebs GmbH

Wallbrunnstrasse 24

79539 Lörrach, Germany

Phone: +49 7621 1612 749

Fax: +49 7621 1612 780

E-mail: [info@zeramex.com](mailto:info@zeramex.com)

Web: [www.zeramex.com](http://www.zeramex.com)

## Global

You can find the contact details of all sales partners on our website

**[www.zeramex.com/contact](http://www.zeramex.com/contact)**



# Zeramex XT

For natural red-white aesthetics





